

FUSION®

User / Installation Manual

Marine HD Widescreen LCD Television With DVD

TV-M160DVD, TV-M190DVD, TV-M220DVD



FUSION

FUSION



WARNING
RISK OF ELECTRIC SHOCK
DO NOT OPEN

WARNING: TO REDUCE THE RISK OF ELECTRIC SHOCK DO NOT REMOVE COVER OR BACK. NO USER-SERVICEABLE PARTS INSIDE. REFER SERVICING TO QUALIFIED SERVICE PERSONNEL.

The lightning flash with arrowhead symbol, within an equilateral triangle, is intended to alert the user to the presence of uninsulated "dangerous voltage" within the product's enclosure that may be of sufficient magnitude to constitute a risk of electric shock to persons.

The exclamation point within an equilateral triangle is intended to alert the user to the presence of important operating and maintenance (servicing) instructions in the literature accompanying the appliance.

 Double insulation this is class II apparatus.

The mains plug used as the disconnect device. The disconnect device shall remain readily operable.

WARNING: To reduce the risk of electric shock do not expose this apparatus to rain or moisture and objects filled with liquids, such as vases, should not be placed on this apparatus.

WARNING: According to the industrial standards, there are a certain number of defective pixels both bright and dark that are acceptable. Although we produce panel with more than 99.99 percent active cells, there still may be some cells that do not produce light or remain lit. For more information, please contact sales or the technical support.

CAUTION

Changes or modifications not expressly approved by the party responsible for compliance with the FCC Rules could void the user's authority to operate this equipment.

TV/CATV MODE SELECTION

When shipped from the factory, the TV/CATV menu option is set to the "TV" mode. If using CATV, set the menu option to "CATV" (Cable Television)

Important Safety Instructions

- 1. READ INSTRUCTIONS** - All the safety and operating instructions should be read before the unit is operated.
- 2. RETAIN INSTRUCTIONS** - The safety and operating instructions should be retained for future reference.
- 3. HEED WARNINGS** - All warnings on the unit and in the operating instructions should be adhered to.
- 4. FOLLOW INSTRUCTIONS** - All operating and use instructions should be followed.
- 5. CLEANING** - Unplug this unit from the wall outlet before cleaning. Do not use liquid cleaners or aerosol cleaners. Use a damp cloth for cleaning the exterior cabinet only.
- 6. ATTACHMENTS** - The manufacturer of this unit does not make any recommendations for attachments, as they may cause hazards.
- 7. WATER AND MOISTURE** - Do not use this unit near water. For example, near a bathtub, washbowl, kitchen sink, laundry tub, in a wet basement, or near a swimming pool.
- 8. ACCESSORIES** - Do not place this unit on an unstable cart, stand, tripod, bracket, or table. The unit may fall, causing serious injury, and serious damage to the unit. An appliance and cart combination should be moved with care. Quick stops, excessive force, and uneven surfaces may cause the appliance and cart combination to overturn.

PORTABLE CART WARNING



S3126A

- 9. VENTILATION** - Slots and openings in the cabinet back or bottom are provided for ventilation, to ensure reliable operation of the unit and to protect it from overheating. These openings should never be blocked by placing the unit on a bed, sofa, rug, or other similar surface. This unit should never be placed near or over a radiator or heat source. This unit should not be placed in a built-in installation, such as a bookcase, or rack unless proper ventilation is provided or the manufacturer's instructions have been adhered to.
- 10. POWER SOURCE** - This unit should be operated only from the type of power source indicated on the rating plate. If you are not sure of the type of power supply to your home, consult your appliance dealer or local power company. For units intended to operate from battery power, or other sources, refer to the operating instructions.
- 11. POLARIZATION** - This unit is equipped with a polarized alternating current line plug (a plug having one blade wider than the other). This plug will fit into the power outlet only one way. This is a safety feature. If you are unable to insert the plug fully into the outlet, try reversing the plug. If the plug still fails to fit, contact your electrician to replace your obsolete outlet. Do not defeat the safety purpose of the polarized plug.
- 12. POWER-CORD PROTECTION** - Power supply cords should be routed so that they are not likely to be walked on or pinched by items placed upon or against them, paying particular attention to cords at plugs, convenience receptacles, and the point where they exit from the appliance.
- 13. LIGHTNING** - To protect your unit during a lightning storm, or when it is left unattended and unused for long periods of time, unplug it from the wall outlet and disconnect the antenna or cable system. This will prevent damage to the unit due to lightning and power line surges.
- 14. POWER LINES** - An outside antenna system should not be located in the vicinity of overhead power lines, or other electric light or power circuits, or where it can fall into such power lines or circuits. When installing an outside antenna system, extreme care should be taken to keep from touching such power lines or circuits as contact with them might be fatal.

WARNING: Do not leave any stationary images, patterns, PIP box, or letterbox images on the screen for an extended period of time. Also, do not display the same stationary patterns frequently. This may result in permanent ghost images on the display unit. This type of damage is not covered under warranty. Examples of this type of situation can be but not limited to the following: side bar images, stock market report bars, video game patterns, closed captioning, shopping channel logo, price display, and letterbox black bars. To prevent this type of damage, display constant moving images that fill the screen as often as possible.

15. OVERLOADING - Do not overload wall outlets and extension cords as this can result in a risk of fire or electric shock.

16. OBJECT AND LIQUID ENTRY - Do not push objects through any openings in this unit as they may touch dangerous voltage points or short out parts that could result in fire or electric shock. Never spill or spray any type of liquid into the unit.

17. OUTDOOR ANTENNA GROUNDING - If an outside antenna or cable system is connected to the unit, be sure the antenna or cable system is grounded to provide some protection against voltage surges and built-up static charges. Section 810 of the National Electrical Code, ANSI/NFPA 70, provides information with respect to proper grounding of the mast and supporting structure, grounding of the lead-in wire to an antenna discharge unit, size of grounding conductors, location of antenna discharge unit, connection to grounding electrodes, and requirements for the grounding electrode.

18. SERVICING - Do not attempt to service this unit yourself as opening or removing covers may expose you to dangerous voltage or other hazards. Refer all servicing to qualified service personnel.

19. DAMAGE REQUIRING SERVICE - Unplug this unit from the wall outlet and refer servicing to qualified service personnel under the following conditions:

- A. When the power-supply cord or plug is damaged.
- B. If liquid has been spilled, or objects have fallen into the unit.
- C. If the unit has been exposed to rain or water.
- D. If the unit does not operate normally by following the operating instructions. Adjust only those controls that are covered by the operating instructions, as an improper adjustment of other controls may result in damage and will often require extensive work by a qualified technician to restore the unit to its normal operation.
- E. If the unit has been dropped or the cabinet has been damaged.
- F. When the unit exhibits a distinct change in performance, this indicates a need for service.

20. REPLACEMENT PARTS - When replacement parts are required, be sure the service technician uses replacement parts specified by the manufacturer or those that have the same characteristics as the original part. Unauthorized substitutions may result in fire, electric shock or other hazards.

21. SAFETY CHECK - Upon completion of any service or repairs to this unit, ask the service technician to perform safety checks to determine that the unit is in proper operating condition.

22. HEAT - The product should be situated away from heat sources such as radiators, heat registers, stoves, or other products (including amplifiers) that produce heat.

23. NOTE TO CATV SYSTEM INSTALLER - This reminder is provided to call the CATV system installer's attention to Article 820-40 of the NEC that provides guidelines for proper grounding and, in particular, specifies that the cable ground shall be connected to the grounding system of the building, as close to the point of cable entry as practical.

EXAMPLE OF ANTENNA GROUNDING AS PER NATIONAL ELECTRICAL CODE S2898A

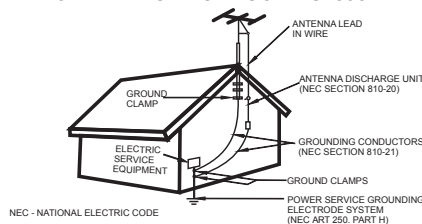

Contents

Connections And Setup	2
Remote Control	3
Button Description	4
Antenna Connection	4
AV Connection	4
S-Video Connection	4
Y Pb Pr Connection	5
VGA Connection	5
HDMI Connection	5
USB Connection	5
Menu Operation	6
EPG (Electronic Program Guide)	6
Source Selection	6
Channel	7
Picture	8
Time	9
Sound	10
Options	10
Lock	11
Media Play Function (DMP)	11
Personal Video Recorder (PVR) File System	12
Specifications	13
Troubleshooting	13

Connections And Setup

Thank you very much for your purchase of this product. Please read this manual carefully and keep it safe for reference.

Please use the power cord designated for the product. When an extension cord is required, use one with the correct power rating. The cord must be grounded. The product should be installed on a flat surface to avoid tipping. Space should be maintained between the back of the product and the wall for proper ventilation. If you would like to mount the TV to the wall, please see "Preparing the LCD for Wall Mounting" below for additional information. Avoid installing the product in the kitchen, bathroom or other places with high humidity.

Preparing Your LCD TV For Wall Mounting

The HDTV can either be kept on the stand or mounted to the wall for viewing. If you choose to mount the HDTV to the wall, please follow the instructions below .

- » Unplug all the cables and cords from your LCD TV.
- » Place the LCD TV face down on a soft and flat surface (blanket, foam, cloth, etc) to prevent any damage to the display.
- » Remove the stand screws allowing the stand to be removed.
- » The mounting bracket is made up of two parts - the wall bracket and the TV bracket. Attach the TV bracket to the TV via the included screws.
- » Attach the wall bracket to the wall with appropriate screws. Ensure the wall is suitable to hold the weight of the TV.
- » Slide the TV bracket into the wall bracket.

Important Notes

RESET: Like any product controlled by microprocessors this TV may hang or become unresponsive, in the unlikely event this occurs simply disconnect the power and reconnect after 10 seconds.

REMOTE: To prevent leakage which may result in bodily harm or damage to the remote:

1. Install AAA batteries correctly, and make sure polarities are correctly aligned with the battery compartment markings.
2. Do not mix batteries (OLD and NEW or CARBON and ALKALINE ,etc)
3. Remove batteries when the remote is not used for a long time.

My music, movie or image files do not display?

Due to the large variation of file sizes, compression formats and codec available, playback of all files cannot be guaranteed.

I cannot record onto my USB flash drive?

FAT 32 formatted flash drive is required.

Time Shift functionality does work work?

FAT 32 formatted flash drive is required.

Warning! Do not keep images on the screen for a long time

To prevent the screen from burn in, do not leave static images including menu screens displayed for a period of time. Burn in is not covered under warranty provision.

ATTENTION: Do not try to update the TV unless directed by a service technician.

Product misconfigured by an incorrect update is not covered under warranty.



Remote Control



POWER - Switch between Standby and On
TIME SHIFT - Pause live TV. Press in DTV source to activate the Time Shift function. (Requires USB flash drive connection)
AUTO - AUTO adjust resolution refresh rate in VGA mode.
MUTE - Press to mute the audio. Press again or press VOL+ to resume.
P.MODE - Select the picture mode.
S.MODE - Select the audio mode.
AUDIO - Press to change the language of the audio in DTV or DVD source.
I/II - Select NICAM mode. Only available in TV programs with NICAM transmission. Default mode is mono.

NUMBER BUTTONS - Press **0-9** to select a TV channel directly when watching TV. The channel changes after 2 seconds or press **ENTER** button to change immediately.
REC MENU - Press to enter recorded files menu.
 Return to the previously viewed program.
GOTO - In DVD source press to cycle to a desired position.

SLEEP - Set the TV to turn off after a specified time.
ASPECT - Select the screen aspect.
SOURCE - Select the TV source.
▲/▼/◀/▶/ENTER - Allows you to navigate the on-screen menus and adjust the system settings to your preference.

▲ Eject in DVD source.
 Press in Time Shift mode to minimise onscreen display
D.MENU - Display the DVD menu.
SETUP - DVD menu setup.
D.DISP - Press to cycle the DVD disc information.
DISPLAY - IN DTV source press to show and minimise onscreen program information.
EXIT - Exit the menu or sub menu.
MENU - Access the on-screen menu.
CH+/- - Press to change channel.
VOL+/- - Press to increase or decrease volume.
MEDIA - Access DMP menu.
REC - Press to record the program immediately.

▶|| - Play/pause
■ - Stop playing
A-B - Repeat the segment between A and B
REPEAT - Press to change the playing mode
◀◀/▶▶ - Play fast backward/forward
I◀◀/▶▶I - Play previous/next media file
EPG - Press to display EPG information (Electronic Program Guide).
FAV - Press to display favorite programs.
SUBTITLE - Select subtitle language.
TV/RADIO - Press to switch between DTV and radio programs.
TITLE - Press to display Title information.
TEXT - Press to turn the Teletext On and Off. **Note:** The following buttons are for use in teletext mode
INDEX - Press to return to the index/initial page.
MIX - Press to display the picture and the teletext at the same time
HOLD - HOLD On or Off the current page display
SUBPAGE - Display a sub-page of upper options
REVEAL - Reveal or Hide the hidden words.
SIZE - Change the size of display in Teletext mode
CANCEL - Press to return to TV mode while teletext 'searches' for a page. When the required page is found, the page number will appear at the top of the TV picture, press again to return to teletext.

Button Description



- » Press **VOL-** or **VOL+** to decrease or increase the sound level.
- » Press **CH-** or **CH+** to scan through channels.
- » Press **MENU** to bring up the main menu screen.
- » Press **SOURCE** to select the input source.
- » Press **▶||** to play/pause
- » Press **▲** to eject the disc
- » Press **POWER** button to alternate between standby and 'on' modes.
Red light indicates TV is in standby mode, **Green** indicates TV is on.



POWER: DC 12V input

HDMI: Connect the HDMI output jack of DVD

VGA: Connect the PC-RGB output jack of PC

S-VIDEO: Connect the S-VIDEO output jack of DVD or VCR

VIDEO: Connect the video output jack of DVD or VCR

PC AUDIO INPUT: Connect the audio output jack of PC audio.

EARPHONE: Connect the headphone

RF IN: Connect the antenna

USB: Connect the USB flash drive to play multimedia files

Y/Pb/Pr IN: Connect component Video

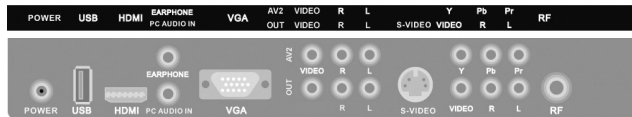

Antenna Connection

To ensure good picture and sound, a Terrestrial TV antenna system needs to be installed.

Video / Audio Out

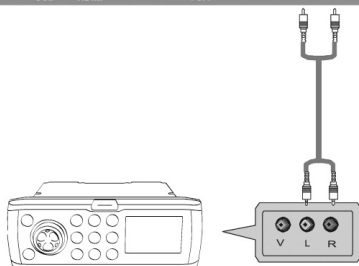

Connect the **AUDIO** output from the television to the **AUX** input of the device using the RCA cable (White and Red [left and right audio]).

AV Connection

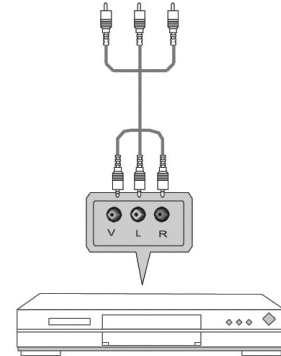

Connect the **VIDEO** and **AUDIO** output jack of the DVD or VCR to the **AV IN** jacks using the RCA cable (Yellow [Video], White and Red [left and right audio]).

Select the AV input source using the **SOURCE** button on the remote.

S-Video Connection

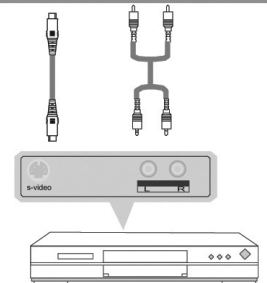

Connect the **S-VIDEO** output jack of the DVD or VCR to the **S-VIDEO** jacks.

Connect the **AUDIO** output jack of the DVD or VCR to the **Audio In** jacks using the RCA cable.

Select the S-Video input source using the **SOURCE** button on the remote.

Y Pb Pr Connection

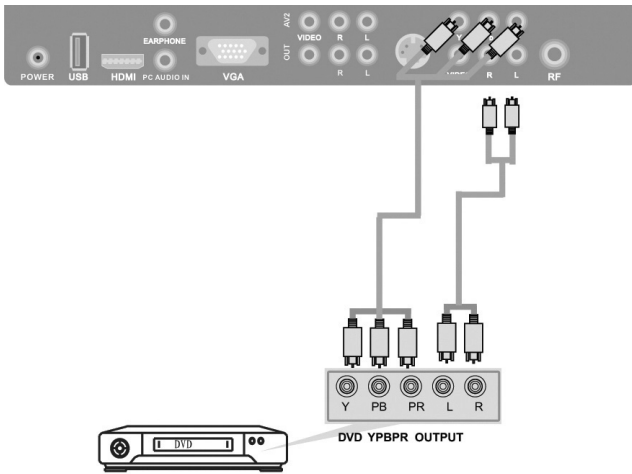

Connect the **Y Pb Pr** output of the accessory device to the **Y Pb Pr** input on the TV. The picture quality is improved, compared to connecting a regular VCR video input.

Connect the Audio output of the accessory device to the Audio input jacks on the TV using the **RCA** cable.

Select the **Y Pb Pr** input source using the **SOURCE** button on the remote.

HDMI Connection

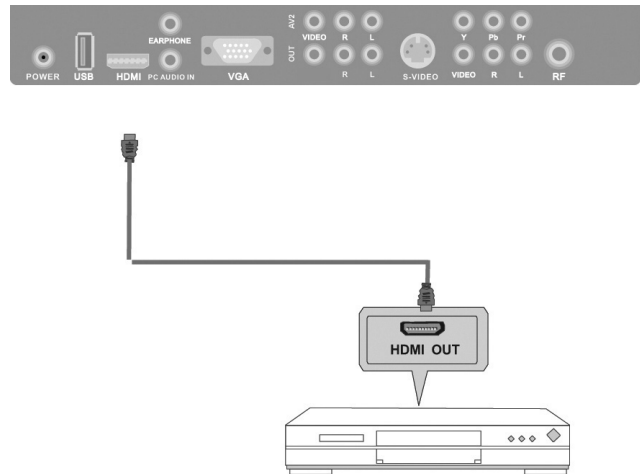

Connect the **HDMI** output of the accessory device to the **HDMI** input on the TV.

Select the **HDMI** input source using the **SOURCE** button on the remote.

VGA Connection

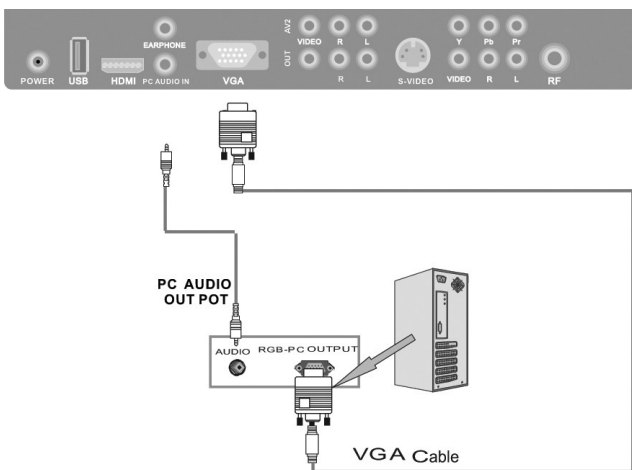

Connect the **RGB** output of the PC to the **VGA** input on the TV.

Connect the PC audio output of the PC to the PC Audio input jacks on the TV

Select the **VGA** input source using the **SOURCE** button on the remote.

USB Connection

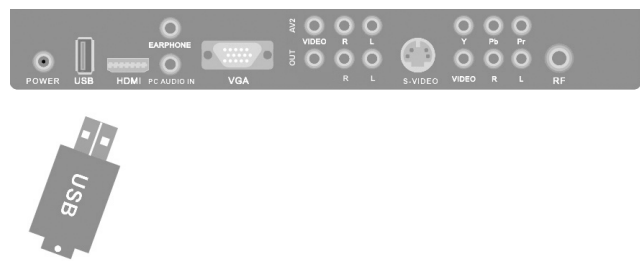

Insert the **USB** flash drive into the **USB** slot on the TV.

Select the **USB** input source using the **MEDIA** button on the remote.

Menu Operation

Menu Operation

This section explores the menus of your TV. Each menu is outlined and detailed to help you get the most from your TV.

To access the main menu page press **MENU** on the remote.

Press **◀/▶** to cycle through the seven main functions below:

- » **CHANNEL**
- » **PICTURE**
- » **SOUND**
- » **TIME**
- » **OPTION**
- » **LOCK**

EPG (Electronic Program Guide)

Only available for DTV source.

- » Press **EPG** on remote to enter menu
- » Follow on screen instructions for EPG control and navigation.

Source Selection

To access the input source's press **SOURCE** on the remote.

- » Press **▲/▼** to move the cursor
- » Press **OK** to confirm your selection

Input Source
DTV
ATV
AV1
AV2
Component1
Component2
VGA
HDMI
⊖ OK

Channel

Press **MENU** button on the remote to enter the **CHANNEL** page below:

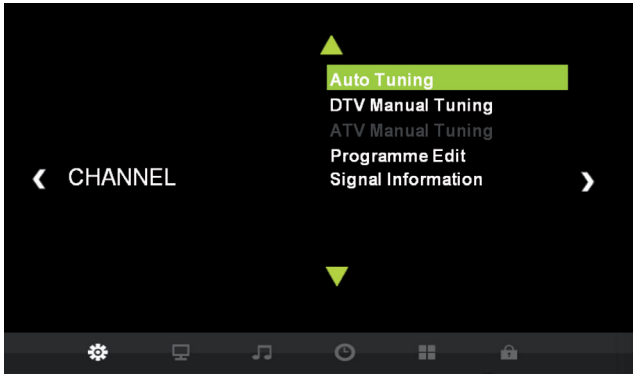

Auto Tuning:

ATV and DTV auto program, operate as below:

- » Select **Auto Tuning** and press **OK**.
- » To return to previous page press **MENU** or **Exit**
- » To interrupt tuning, press **MENU** or **Exit**. The below confirmation screen will appear. Press **◀** to confirm exit, or **▶** to continue tuning.

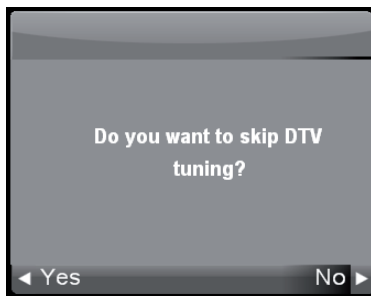
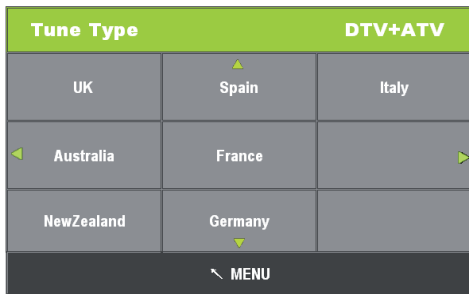

DTV Manual Tuning

Input source is DTV, operate as below:

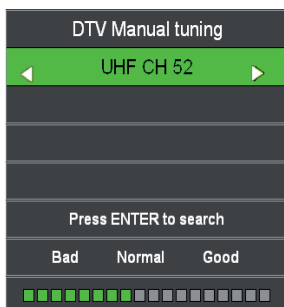

- » From the **CHANNEL** menu select **DTV Manual Tuning**
- » Select channel number by pressing **◀/▶**
- » Press **ENTER** to search

ATV Manual Tuning

Input source is ATV, operate as below:

- » From the **CHANNEL** menu select **ATV Manual Tuning**
- » Select **Storage To 1** and enter channel that you wish to store program to (1-100).
- » Select **System DK** and select TV system.
- » Select **Search** to start **ATV Manual Tuning**. To interrupt press **MENU** or **Exit**
- » Select **Fine Tune** and use **◀/▶** to fine tune program



Program Edit

- » From the **CHANNEL** menu select **Program Edit**

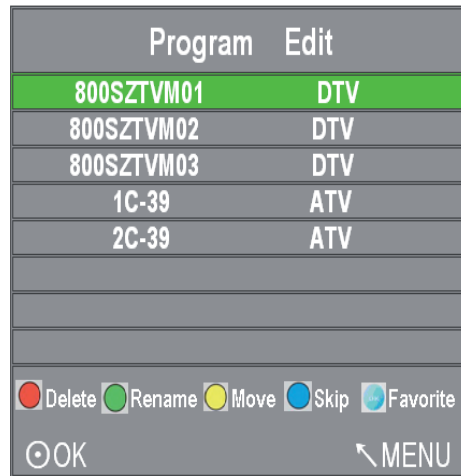

- » Select the program using **▲/▼** and press the following:
 - Delete Program:** Delete selected program
 - Rename Program:** Edit program name
 - Reorder Program:** Select first program and then select the second program. The two programs will swap order.
 - Skip Program:** Select program to be skipped.
 - Favourite:** Press the remote **FAV** button to activate. Select program to add to favourite list.

Signal Information

Displays the signal information of current program.

- » From the **CHANNEL** menu select **Signal Information**

Picture

Press **MENU** button on the remote and ◀/▶ use to cycle to **PICTURE** page below:

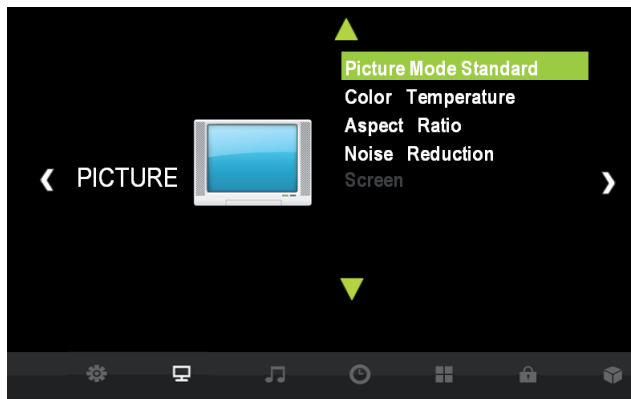

Picture Mode:

- » Select **Picture Mode**
- » Press ◀ or ▶ to cycle through available picture modes: **Standard, Mild, User** and **Dynamic**.
- Note:** Contrast, Brightness, Color and Sharpness can only be changed under **User**.

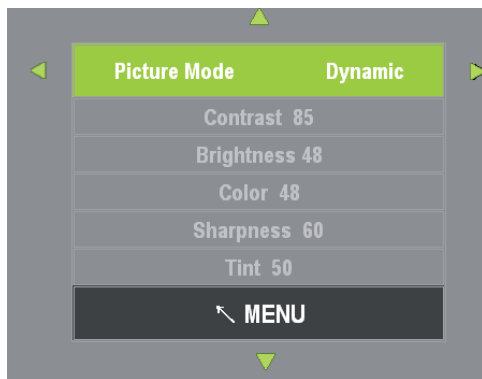

Color Temperature:

- » From the **PICTURE** menu select **Color Temperature**
- » Press ◀ or ▶ to cycle through available color temperature modes: **Medium, User, Warm** and **Cool**.
- Note:** Red, Green, and Blue can only be changed under **User**.

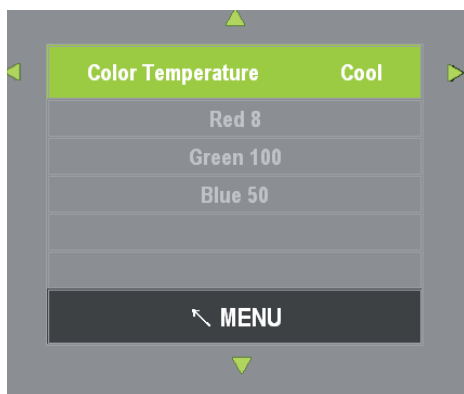

Aspect Ratio:

- » From the **PICTURE** menu select **Aspect Ratio**
- » Press ▲/▼ to select Aspect Ratio: **Auto, 4:3** and **Full**.

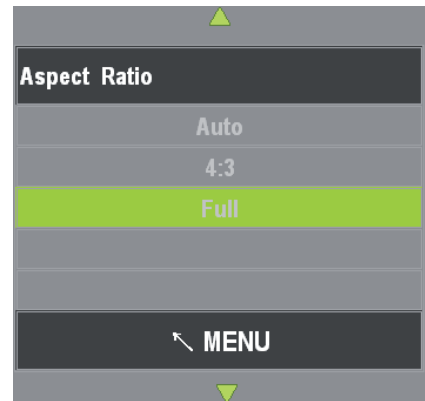

Noise Reduction:

- » From the **PICTURE** menu select **Noise Reduction**
- » Press ▲/▼ to select Noise Reduction: **Off, Low, Middle, High** and **Default**.

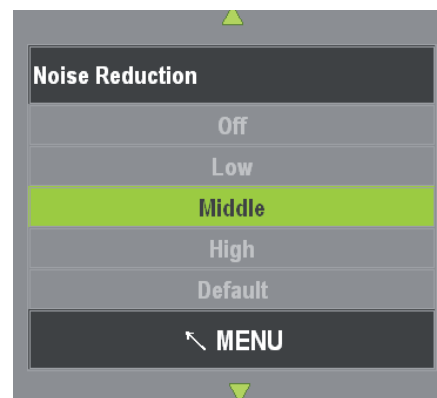

Screen:

- » From the **PICTURE** menu select **Screen**
- » Press ▲/▼ to select Screen Options: **Auto Adjust, Horizontal Position, Vertical Position, Size** and **Phase**.

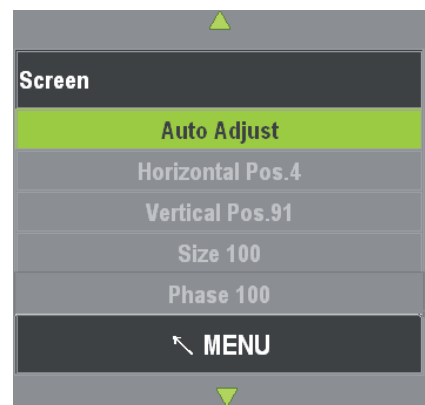

Time

Press **MENU** button on the remote and ◀/▶ use to cycle to **TIME** page below:

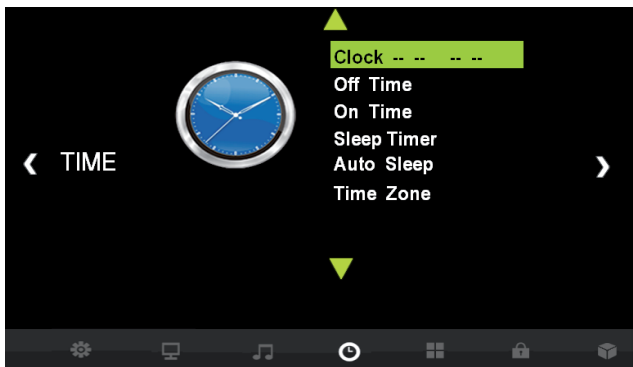

Clock:

Set TV system time settings

- » Select **Clock**
- » Press ◀ or ▶ to cycle through available clock settings:
Date, Month, Year, Hour and Minute.

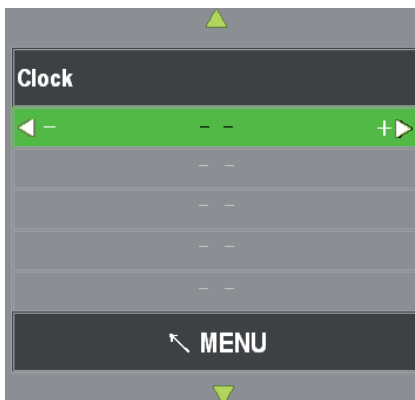

Sleep Timer:

- » From the **TIME** menu select **Sleep Timer**
- » Select Sleep Timer setting:
Off, 10min, 20min, 30min, 60min, 90min, 120min, 180min or 240min

Auto Sleep:

- » From the **TIME** menu select **Auto Sleep.**
- » Select **ON** or **OFF**

Time Zone:

- » From the **TIME** menu select **TIME.ZONE.**
- » Select your Time Zone

Off Time:

Set TV system to turn off automatically.

- » From the **TIME** menu select **Off Time**
- » Press ◀ or ▶ to select Off Time mode:
Off, Once, Every Day, Mon - Fri, Mon - Sat, Sat -Sun or Sunday
- » Set the **Hour** and **Minute**

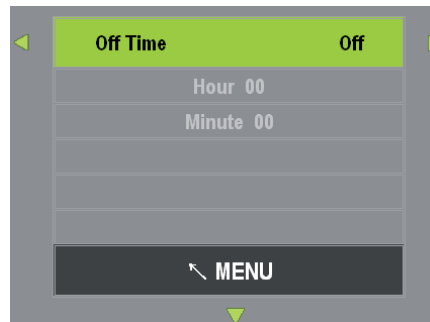

On Time:

Set TV system to turn on automatically.

- » From the **TIME** menu select **On Time**
- » Press ◀ or ▶ to select On Time mode:
Off, Once, Every Day, Mon - Fri, Mon - Sat, Sat -Sun or Sunday
- » Set the **Hour** and **Minute**
- » Select the input source
- » If **ATV** or **DTV** source is selected, also select the program number
- » Select the **Volume** setting at turn on

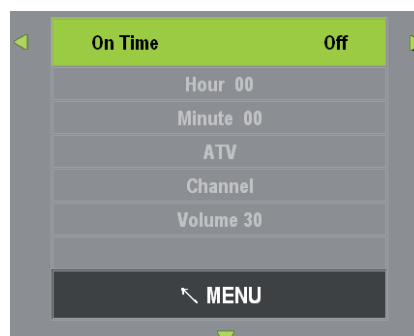

Sound

Press **MENU** button on the remote and ◀/▶ use to cycle to **SOUND** page below:

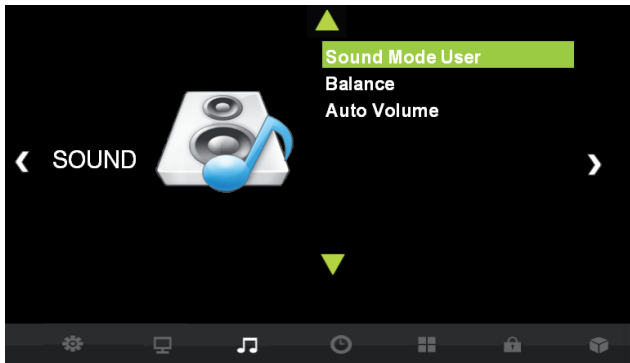

Sound Mode:

- » Select **Sound Mode**
- » Press ◀ or ▶ to cycle through available sound modes: **Standard, Music, Movie, Sports** and **User**.
- Note:** Treble and Bass can only be changed under **User**.

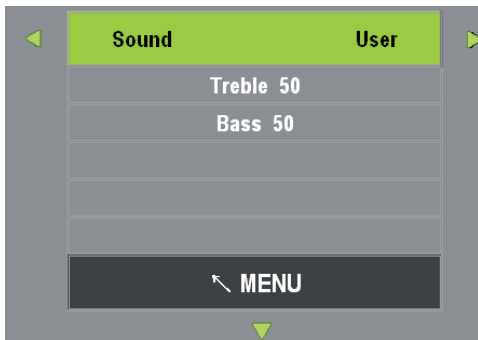

Adjust Balance:

- » From the **SOUND** menu select **Balance**

Auto Volume:

- » From the **SOUND** menu select **Auto Volume**.
- » Select **ON** or **OFF**

Options

Press **MENU** button on the remote and ◀/▶ use to cycle to **OPTION** page below:

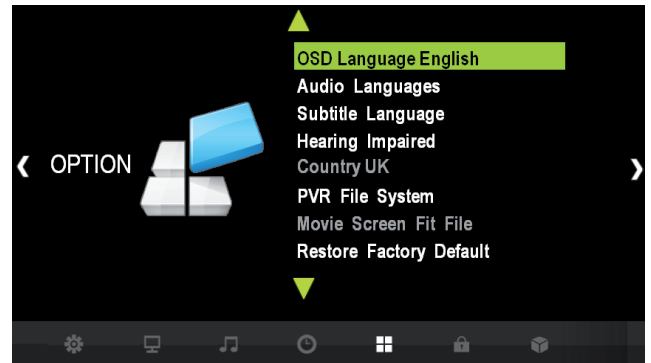

OSD Language:

Set current menu language

- » Select **OSD Language**

Audio Language:

Set audio language

- » Select **Audio Language**
- » Press ◀ or ▶ to cycle through available languages:

Subtitle Language:

Set subtitle language

- » Select **Subtitle Language**
- » Press ◀ or ▶ to cycle through available languages:

Hearing Impaired:

- » Select **Hearing Impaired**
- » Select **ON** or **OFF**

PVR File System:

(Reference 'PVR File System' on following page)

Restore Factory Default:

- » Select **Restore Factory Default** to restore to initial settings

Lock

Press **MENU** button on the remote and ◀/▶ use to cycle to **LOCK** page:
Note: All options are initially greyed out until password is entered (see below)

Lock System:

Set TV system time settings

- » Select **Lock System**
- » Enter factory default password (**0000**)

Set Password:

- » From the **LOCK** menu select **SET PASSWORD**
- » Change password from factory default (above):

Block Program:

- » From the **LOCK** menu select **Block Program**.
- » Select channels to block and require password to watch.

Parental Guidance:

- » From the **LOCK** menu select **Parent Guidance**.
- » Select age restriction

Media Play Function (DMP)

Access media files (Photo's, Music, Movie's and Text) via the TV's USB port.

Press **MEDIA** button on the remote.

Picture:

Supported picture formats include .jpg/jpeg and .gif
 The image should be no bigger than 3000 x 3000 pixels.

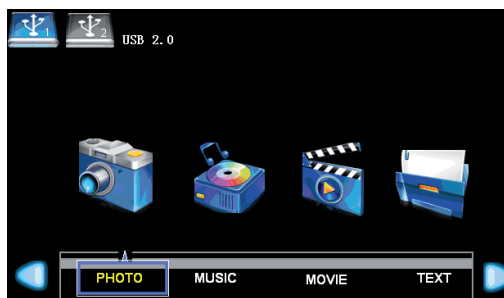

- » Select **Photo** source
- » Use ◀ or ▶ to select **C** and enter photo view list
- » Select the desired Photo/s
- » Press play to view

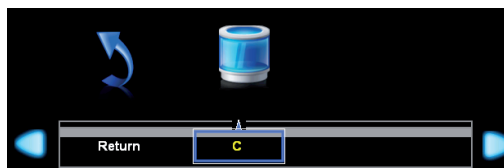

Music:

Supported music formats include .mp3

- » Select **Music** source
- » Use ◀ or ▶ to select **C** and enter music view list
- » Select the desired music track/s
- » Press play to begin playback

Movie:

Supported movie formats include .mpg, .vob, .avi, mp4 and .dat
 The maximum matrix is below MPEG2 MA/ML.

- » Select **Movie** source
- » Use ◀ or ▶ to select **C** and enter movie view list
- » Select the desired movie.
- » Press play to begin playback

Text:

Supported text format is .txt

- » Select **Text** source
- » Use ◀ or ▶ to select **C** and enter text view list
- » Select the desired text.

PVR File System

(Only for DTV source)

The PVR File System Menu Description

SELECT DISK: Select the PVR file system disk

Check PVR File System: Check the disk file format.

USB Disk: Display the USB Disk activation status, "PASS" flag is activation



Format: Format the USB device, create PVR file system format on the USB device

Time Shift Size: Show the TSR capacity information

Speed: Read and write speed.

Free Record Limit: Set the recording set-up time, unit is hours.

Digital Video Record

- » Insert a USB device and enter the PVR File System page.
- » Select **Check PVR File System**, if USB device not previously formatted the system will automatically prompt USB disk formatting.
- » The size of the USB device affects the recording time available.
- » To record a DTV program press the  button. The recording will continue until the **Stop** button is pressed or the USB device is full.
- » Press the  button to shrink the on-screen information.
- » Pressing the **REC MENU** button will open the recorded program page.
- » Recorded Programs can be viewed or deleted.

Important Recording Information

- » The USB device must be at least 1 GB.
- » When formatting a USB device all contents will be deleted. Formatting will fail if the USB device contains a virus or any other defect.
- » PVR function is only available in DTV source
- » USB device must be compatible USB 2.0 HS specification.

Specifications

	TV-M160DVD	TV-M190DVD	TV-M220DVD
Screen size, visible	16" Wide Screen TFT LCD	19" Wide Screen TFT LCD	22" Wide Screen TFT LCD
Screen Format	16:9	16:9	16:9
Resolution	1366 x 768 Pixel	1366 x 768 Pixel	1366 x 768 Pixel
Max. contrast ratio	500:1	1000:1	1000:1
Brightness (Typical)	250 cd/m2	250 cd/m2	300 cd/m2
Response Time (Typical)	8ms	5ms	5ms
Display Colours	16.7M	16.7M	16.7M
Viewing Angle (Typical)	H:90°, V:65°	H:170°, V:160°	H:170°, V:160°
Power Supply	110-240V AC, 12V DC 5 metre cable	110-240V AC, 12V DC 5 metre cable	110-240V AC, 12V DC 5 metre cable
Power Consumption	30W	48W	52W
Standby Power Dissipation	≤1W	≤1W	≤1W
Colour System	PAL	PAL	PAL
Sound System	BG/DK/I	BG/DK/I	BG/DK/I
AV Playback	PAL/SECAM/NTSC	PAL/SECAM/NTSC	PAL/SECAM/NTSC

All Models Feature:

- » Conformal coated PCB
- » Built-in DVD/CD drive
- » Built in DVB-T digital tuner
- » HDMI input for true digital connection
- » USB connection for digital media playback
- » PVR functionality (record digital TV)**
- » Component and Composite video inputs
- » VGA port for connection to a PC
- » S-Video
- » Multi-language On-screen display
- » Closed Caption Decoder
- » Parental Lock
- » Sleep Timer
- » Built in speakers (4W x 2)
- » Wall mounting bracket included

Troubleshooting

PROBLEM	SOLUTION
No picture or sound	Check the power supply is plugged in and turned on.
Picture is OK but no sound	Make sure the volume is not set to minimum or mute. Turn off the TV and turn back on.
Remote control doesn't work	Check the battery connection is correct. Check the batteries. Make sure no obstacles are between the sensor of the remote and TV
No TV Signal	Check the source is set to ATV or DTV. Check the antenna signal status.
No external video signal	Check the source is set to AV
Picture lacks colour or is too dark	Check colour, brightness and contrast settings
All channels lose colour intermittently	Check the antenna in case it is broken, disconnected or damaged.
Poor reception, loss of colour	Check channel is tuned correctly
Diagonal stripes on picture	Receiver may be affected by interference. e.g. nearby radio broadcasting transmitter or from another TV receiver.
Ghost images appear	Antenna direction may have been changed by a storm or strong wind. Ghost images are caused from both the signal travelling directly from the transmitter and a signal reflected from a hill or large building. Direction of the antenna should be chosen to avoid this situation.
USB media files don't work	FAT 32 formatted flash drive required. Reformat if required.
Time Shift and PVR don't work	FAT 32 formatted flash drive required. Reformat if required.



www.fusionelectronics.com

FUSION Electronics New Zealand

Ph: +64 9 369 2900

FUSION Electronics Australia

Ph: +61 1300 736 012

FUSION Electronics Europe

Ph: +44 845 299 7586

FUSION Electronics USA

Ph: +1 623 580 9000