

clarion®

Owner's manual
Mode d'emploi
Manual de instrucciones

DB 185MP

CD/MP3/WMA RECEIVER
AUTORADIO CD/MP3/WMA
RECEPTOR CD/MP3/WMA

This equipment has been tested and found to comply with the limits for a Class B digital device, pursuant to Part 15 of the FCC Rules.

These limits are designed to provide reasonable protection against harmful interference in a residential installation.

This equipment generates, uses, and can radiate radio frequency energy and, if not installed and used in accordance with the instructions, may cause harmful interference to radio communications. However, there is no guarantee that interference will not occur in a particular installation.

If this equipment does cause harmful interference to radio reception, which can be determined by turning the equipment off and on, the user is encouraged to consult the dealer or an experienced radio technician for help.

Cet appareil a été testé et jugé conforme aux limites des appareils numériques de Classe B, aux termes de la Section 15 des Règlements FCC.

Ces limites ont pour but d'assurer une protection raisonnable contre les interférences parasites dans une installation résidentielle.

Cet appareil engendre, utilise et peut émettre une énergie radioélectrique et, s'il n'est pas installé et utilisé en stricte conformité avec ces instructions, il peut provoquer des interférences parasites sur les liaisons radiophoniques. Ceci ne garantit par pour autant qu'une installation particulière ne provoquera aucune interférence.

Si l'appareil engendre des interférences sur la réception des ondes radio, ce qui peut être vérifié en mettant l'appareil hors tension puis sous tension, l'utilisateur est invité à consulter son revendeur ou un technicien expérimenté en radio pour lui demander conseil.

Este equipo ha sido probado y se ha comprobado que cumple con los límites de un dispositivo digital de clase B, según lo indicado en la Parte 15 de las Normas de FCC.

Estos límites se han establecido para ofrecer una protección razonable contra interferencias perjudiciales en instalaciones residenciales.

Este equipo genera, emplea, y puede radiar energía de radiofrecuencia y, si no se instala y emplea de acuerdo con las instrucciones, puede causar interferencias perjudiciales en las radiocomunicaciones. Sin embargo, no se garantiza que las interferencias no ocurran en una instalación en particular.

Si este equipo causa interferencias perjudiciales en la recepción de radio, lo cual podrá determinarse conectando y desconectando la alimentación del equipo, se aconseja al usuario que consulte al abastecedor o que pida ayuda a un técnico en radio experimentado.

MODEL: Clarion

12V \ominus GROUND
AM 530-1710kHz / FM 87.9-107.9MHz

THIS DEVICE COMPLIES WITH PART 15 OF THE FCC RULES. OPERATION IS SUBJECT TO THE FOLLOWING TWO CONDITIONS:
 (1) THIS DEVICE MAY NOT CAUSE HARMFUL INTERFERENCE, AND
 (2) THIS DEVICE MUST ACCEPT ANY INTERFERENCE RECEIVED, INCLUDING INTERFERENCE THAT MAY CAUSE UNDESIRABLE OPERATION.

THIS PRODUCTION COMPLIES WITH DHHS RULES 21 CFR SUBCHAPTER J APPLICABLE AT DATE OF MANUFACTURE.

CLARION CO., LTD
 7-2, SHINTOSHIN-CHUO-KU, SAITAMA-SHI, SAITAMA 330-0081, JAPAN

This product includes technology owned by Microsoft Corporation and cannot be used or distributed without a license from MSLGR.

MANUFACTURED:

SERIAL No.
 PE:

LF 278-
 Clarion Co., Ltd.
 MADE IN

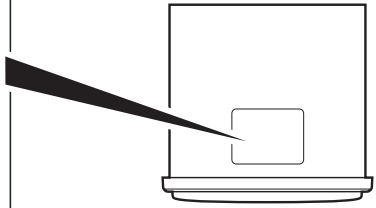

Bottom View of Source Unit
Fond de l'appareil pilote
Vista inferior de la unidad fuente

CLARION PRODUCT REGISTRATION INFORMATION

For USA and Canada only
www.clarion.com

Dear Customer:

Congratulations on your purchase of a Clarion mobile electronic products. We are confident that you'll enjoy your Clarion experience.

There are many benefits to registering your product. We invite you to visit our website at www.clarion.com to register your Clarion product.

We have made product registration simple with our easy to use website. The registration form is short and easy to complete. Once you're registered, we can keep you informed of important product information.

Register at www.clarion.com - it's easy to keep your Clarion product up to date.

Thank you for purchasing this **Clarion** product.

- * Please read this owner's manual in its entirety before operating this equipment.
- * After reading this manual, be sure to keep it in a handy place (e.g., glove compartment).
- * Check the contents of the enclosed warranty card and keep it carefully with this manual.

Contents

1. FEATURES	4
2. PRECAUTIONS	4
Handling Compact Discs	5
3. CONTROLS	6
Names of the Buttons and Their Functions	6
Display Items	8
Display Screen	8
4. DCP (DETACHABLE CONTROL PANEL)	9
5. REMOTE CONTROL	10
Functions of Remote Control Unit Buttons	10
Inserting the Battery	12
6. OPERATIONS	13
Basic Operations	13
Radio Operations	16
CD/MP3/WMA Operations	18
Operations Common to Each Mode	22
7. TROUBLESHOOTING	24
8. ERROR DISPLAYS	25
9. SPECIFICATIONS	26

1. FEATURES



- High Visibility Single Line Display
- 4ch/2V RCA Output
- Front Panel 3.5mm Auxiliary Input

2. PRECAUTIONS

1. When the inside of the car is very cold and the player is used soon after switching on the heater moisture may form on the disc or the optical parts of the player and proper playback may not be possible. If moisture forms on the disc, wipe it off with a soft cloth. If moisture forms on the optical parts of the player, do not use the player for about one hour. The condensation will disappear naturally allowing normal operation.
2. Driving on extremely bumpy roads which cause severe vibration may cause the sound to skip.
3. This unit uses a precision mechanism. Even in the event that trouble arises, never open the case, disassemble the unit, or lubricate the rotating parts.

⚠ CAUTION

USE OF CONTROLS, ADJUSTMENTS, OR PERFORMANCE OF PROCEDURES OTHER THAN THOSE SPECIFIED HEREIN, MAY RESULT IN HAZARDOUS RADIATION EXPOSURE.

THE COMPACT DISC PLAYER SHOULD NOT BE ADJUSTED OR REPAIRED BY ANYONE EXCEPT PROPERLY QUALIFIED SERVICE PERSONNEL.

CHANGES OR MODIFICATIONS NOT EXPRESSLY APPROVED BY THE MANUFACTURER FOR COMPLIANCE COULD VOID THE USER'S AUTHORITY TO OPERATE THE EQUIPMENT.

INFORMATION FOR USERS:

CHANGES OR MODIFICATIONS TO THIS PRODUCT NOT APPROVED BY THE MANUFACTURER WILL VOID THE WARRANTY AND WILL VIOLATE FCC APPROVAL.

Handling Compact Discs

Use only compact discs bearing the  or



mark.

Do not play heart-shaped, octagonal, or other specially shaped compact discs.

Some CDs recorded in CD-R/CD-RW mode may not be usable.

Handling

- Compared to ordinary music CDs, CD-R and CD-RW discs are both easily affected by high temperature and humidity and some of CD-R and CD-RW discs may not be played. Therefore, do not leave them for a long time in the car.

- New discs may have some roughness around the edges. If such discs are used, the player may not work or the sound may skip. Use a ball-point pen or the like to remove any roughness from the edge of the disc.

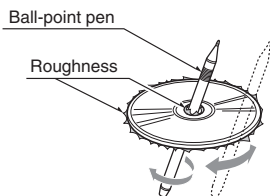

- Never stick labels on the surface of the compact disc or mark the surface with a pencil or pen.
- Never play a compact disc with any cellophane tape or other glue on it or with peeling off marks. If you try to play such a compact disc, you may not be able to get it back out of the CD player or it may damage the CD player.
- Do not use compact discs that have large scratches, are misshapen, cracked, etc. Use of such discs may cause misoperation or damage.
- To remove a compact disc from its storage case, press down on the center of the case and lift the disc out, holding it carefully by the edges.
- Do not use commercially available CD protection sheets or discs equipped with stabilizers, etc. These may damage the disc or cause breakdown of the internal mechanism.

Storage

- Do not expose compact discs to direct sunlight or any heat source.
- Do not expose compact discs to excess humidity or dust.
- Do not expose compact discs to direct heat from heaters.

Cleaning

- To remove fingermarks and dust, use a soft cloth and wipe in a straight line from the center of the compact disc to the circumference.
- Do not use any solvents, such as commercially available cleaners, anti-static spray, or thinner to clean compact discs.
- After using special compact disc cleaner, let the compact disc dry off well before playing it.

3. CONTROLS

Names of the Buttons and Their Functions

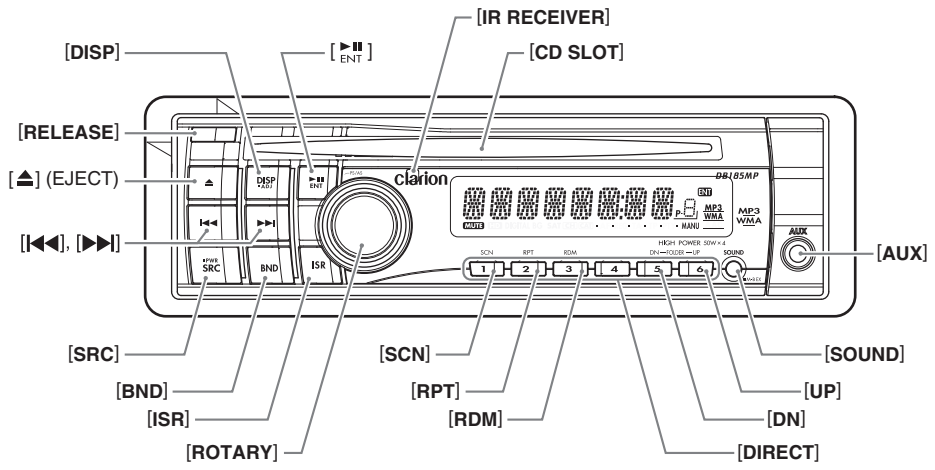

[RELEASE] button

- Press the [RELEASE] button to unlock the DCP.

[DISP] button

- Switch the display indication.
- Press and hold the button for 1 second or longer to enter the adjust mode.

[ENT] button

- Perform preset scan while in the radio mode. When the button is pressed and held, auto store is performed.
- Play or pause a track while in the CD/MP3/WMA mode.
- Confirm various settings.

[IR RECEIVER]

- Receiver for remote control unit. (Operating range: 30° in all directions)

[CD SLOT]

- CD insertion slot.

[AUX] input jack

- The input jack for connecting an external device.

[SOUND] button

- Use the button to switch to the sound adjust mode.
- Press and hold the button for 1 second or longer to turn on or off the MAGNA BASS EXTEND mode.

[UP], [DN] buttons

- Select the folder while in the MP3/WMA mode.
- Use the buttons to perform various settings.

[DIRECT] buttons

- Store a station into memory or recall it directly while in the radio mode.

[RDM] button

- Perform random play while in the CD/MP3/WMA mode.
- Press and hold the button for 1 second or longer to perform folder random play while in the MP3/WMA mode.

[RPT] button

- Perform repeat play while in the CD/MP3/WMA mode.
- Press and hold the button for 1 second or longer to perform folder repeat play while in the MP3/WMA mode.

[SCN] button

- Perform scan play for 10 seconds of each track while in the CD/MP3/WMA mode.
- Press and hold the button for 1 second or longer to perform folder scan play while in the MP3/WMA mode.

[ROTARY] knob

- Adjust the volume by turning the knob clockwise or counterclockwise.

[ISR] button

- Recall ISR radio station in memory.
- Press and hold the button for 2 seconds or longer: Store current station into ISR memory (radio mode only).

[BND] button

- Switch the band, or seek tuning or manual tuning while in the radio mode.

[SRC] button

- Press the button to turn on the power.
- Press and hold the button for 1 second or longer to turn off the power.
- Switch the operation mode among the radio mode, etc.

[◀◀], [▶▶] buttons

- Select a station while in the radio mode or select a track while in the CD/MP3/WMA mode.

This button is used to make various settings.

- Press and hold the button for 1 second or longer to enter the fast-forward or fast-backward mode.

[▲] (EJECT) button

- Eject a disc when it is loaded into the unit.

Display Items

Operation status indication
Frequency, titles, clock, etc. are displayed.



MUTE : MUTE indication
MANU : Manual indication

P. 6 : Preset channel indication (1 to 6)
ENT : Enter indication
MP3 : MP3 indication
WMA : WMA indication

Display Screen

In extreme cold, the screen movement may slow down and the screen may darken, but this is normal. The screen will recover when it returns to normal temperature.

4. DCP (DETACHABLE CONTROL PANEL)

The control panel can be detached to prevent theft. When detaching the control panel, store it in the DCP (DETACHABLE CONTROL PANEL) case to prevent scratches.

We recommend taking the DCP with you when leaving the car.

Removing the DCP

1. Press the [SRC] button for 1 second or longer to switch off the power.
2. Press in the [RELEASE] button.

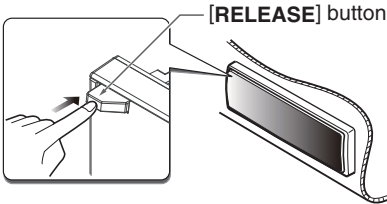

* The DCP is unlocked

3. Remove the DCP.

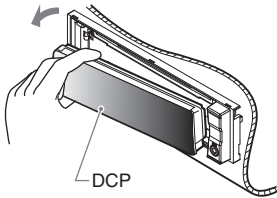

Attaching the DCP

1. Insert the right side of the DCP into the main unit.
2. Insert the left side of the DCP into the main unit.

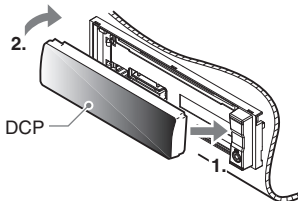

Storing the DCP in the DCP Case

Hold the DCP, in the orientation as shown in the figure below, and put it into the supplied DCP case. (Ensure the DCP is in the correct orientation.)

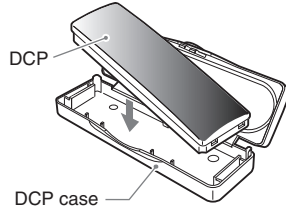

CAUTION

- The DCP can easily be damaged by shocks. After removing it, be careful not to drop it or subject it to strong shocks.
- When the Release button is pressed and the DCP is unlocked, the car's vibrations may cause it to fall. To prevent damage to the DCP, always store it in its case after detaching it.
- The connector connecting the main unit and the DCP is an extremely important part. Be careful not to damage it by pressing on it with fingernails, pens, screwdrivers, etc.

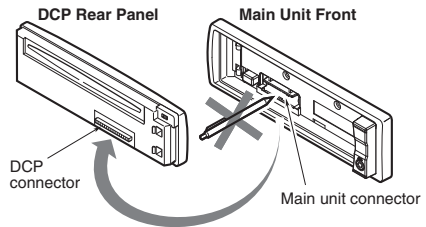

Note:

- If the DCP is dirty, wipe off the dirt with a soft, dry cloth only.

5. REMOTE CONTROL

* If you buy the RCB-176-200 sold separately, you can enjoy the use of the Remote Control function.

Functions of Remote Control Unit Buttons

* Some buttons on the remote control unit have different functions from the corresponding buttons on the main unit.

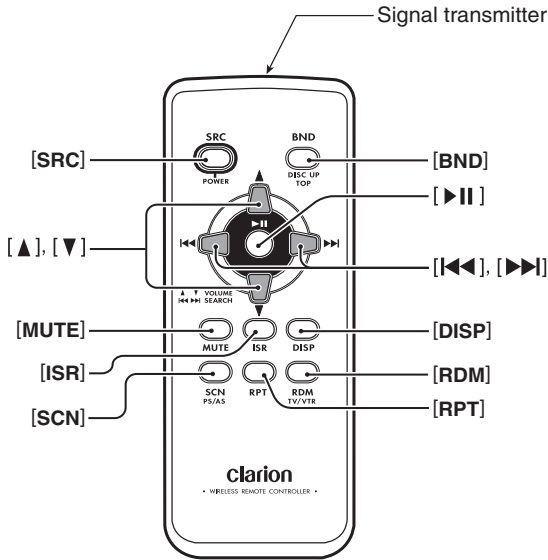

● Shared modes

[SRC] button

- Press the button to turn on the power.
Press and hold the button for 1 second or longer to turn off the power.
- Use to alternate operation mode among the various modes.

[▲], [▼] buttons

- Increases and decreases volume.

[MUTE] button

- Turns mute function on and off.

[ISR] button

- Recalls ISR radio station stored in memory.
- Press and hold the button for 2 seconds or longer to store current station in ISR memory (radio mode only).

[DISP] button

- Press to select the desired display.

● Radio mode

[BND] button

- Switches reception band.

[◀◀], [▶▶] buttons

- Moves preset channels up and down.

[SCN] button

- Press to perform preset scan.
- Press and hold the button for 2 seconds or longer to perform auto store.

● CD/MP3/WMA modes

[BND] button

- Press to play the first track.

[◀◀], [▶▶] buttons

- Press to move the tracks up and down.
- Press and hold the button for 1 second or longer to perform fast-forward/fast-backward.

[▶||] button

- Switches between playback and pause.

[SCN] button

- Press to perform scan play.
- When in MP3/WMA mode, press and hold the button for 1 second or longer to perform folder scan play.

[RPT] button

- Press to perform repeat play.
- When in MP3/WMA mode, press and hold the button for 1 second or longer to perform folder repeat play.

[RDM] button

- Press to perform random play.
- When in MP3/WMA mode, press and hold the button for 1 second or longer to perform folder random play.

Inserting the Battery

- ① Turn over the remote control unit and slide the cover in the direction indicated by the arrow in the illustration.
- ② Insert the battery (CR2025) into the insertion guides, with the printed side (+) facing upwards.
- ③ Press the battery in the direction indicated by the arrow so that it slides into the compartment.
- ④ Replace the cover and slide in until it clicks into place.

Notes:

Misuse may result in rupture of the battery, producing leakage of fluid and resulting in personal injury or damage to surrounding materials. Always follow these safety precautions:

- Use only the designated battery.
- When replacing the battery, insert properly, with +/- polarities oriented correctly.
- Do not subject battery to heat, or dispose of in fire or water. Do not attempt to disassemble the battery.
- Dispose of used batteries properly.

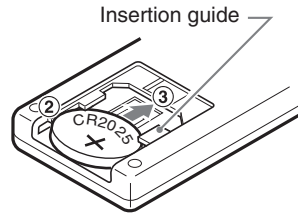
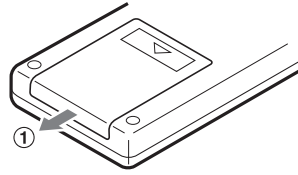

6. OPERATIONS

Note:

- Be sure to read this chapter referring to the front diagrams of chapter “3. CONTROLS” on page 6.

Basic Operations

⚠ CAUTION

Be sure to lower the volume before switching off the unit power or the ignition key. The unit remembers its last volume setting. If you switch the power off with the volume up, when you switch the power back on, the sudden loud volume may hurt your hearing and damage the unit.

Turning on/off the power

Note:

- Be careful about using this unit for a long time without running the engine. If you drain the car's battery too far, you may not be able to start the engine and this can reduce the service life of the battery.

1. Press the [SRC] button.
2. Press and hold the [SRC] button for 1 second or longer to turn off the power for the unit.

Selecting a mode

1. Press the [SRC] button to change the operation mode.
2. Each time you press the [SRC] button, the operation mode changes in the following order:
Radio → CD/MP3/WMA → AUX → Radio...

Adjusting the volume

1. Turning the [ROTARY] knob clockwise increases the volume; turning it counterclockwise decreases the volume.
- * The volume level is from 0 (minimum) to 33 (maximum).

Switching the display

Press the [DISP] button to select the desired display.

- * If the button operation is performed with the screen saver function on, the operation display corresponding to the button operation is shown for about 30 seconds and the display returns to the screen saver display.

For details, refer to the subsection “Turning the screen saver function on or off” in section “Operations Common to Each Mode”.

Basic Operations

Sound Adjustment

You can adjust a sound effect or tone quality to your preference.

To change sound setting

1. Press the [SOUND] button to switch to the sound adjustment selection display.
 - * The factory default sound setting is "Z-EHCR+".
2. Then press the [◀◀] or [▶▶] button to select the sound adjustment mode.

Each time you press the [◀◀] or [▶▶] button, the sound adjustment mode changes as following order:

"Z-EHCR+" ↔ "BASS" ↔ "TREBLE" ↔ "BALANCE" ↔ "FADER" ↔ "NF VOL"

 - * In the case of display blinking "ENT", you can press the [▶ENT] button to adjust the setting value.
 - * The sound adjustment mode will be displayed for 2 seconds before showing the sound setting.
3. Turn the [ROTARY] knob to adjust the selected audio mode.
4. After completing settings, press the [SOUND] button to return to the previous mode.

● Setting the Z-Enhancer Plus

This unit is provided with 4 types of sound tone effects stored in memory.

Select the one you prefer.

* The factory default setting is "OFF".

- 2-1. Select "Z-EHCR+".
- 3-1. Each time you turn the [ROTARY] knob, the tone effect changes in the following order:

"OFF" ↔ "B-BOOST" ↔ "IMPACT" ↔ "EXCITE" ↔ "CUSTOM"

OFF : no sound effect

B-BOOST : bass emphasized

IMPACT : bass and treble emphasized

EXCITE : bass and treble emphasized
mid emphasized

CUSTOM : user custom

When "B-BOOST/IMPACT/EXCITE" is set:

- 3-2. Press the [▶ENT] button.
- 3-3. Turn the [ROTARY] knob to adjust the setting in the range of -3 to +3.
 - * The factory default setting is "0".
- 3-4. Press the [▶ENT] button to return to the previous mode.

When "CUSTOM" is set:

- 3-2. Press and hold the [▶ENT] button for 1 second or longer. Bass/treble characteristics become flat and "FLAT" is show in the display.
- 3-3. Turn the [ROTARY] knob to change to the "OFF" mode.

● Adjusting the bass

This adjustment can be performed only when the Z-Enhancer Plus is set to "CUSTOM".

- 2-1. Select "BASS".
- 3-1. Press the [▶ENT] button.
- 3-2. Press the [◀◀] or [▶▶] button to select as following order.

"B<G 0>" ↔ "B<F 60>" ↔ "Q 1"
- 3-3. Turn the [ROTARY] knob to adjust the gain, the F (center frequency) and the Q.

B<G 0> : The factory default setting is "0".
(Adjustment range: +7 to -7)

B<F 60> : The factory default setting is "60".
(Adjustment range: 60/80/100/200)

Q 1 : The factory default setting is "1".
(Adjustment range: 1/1.25/1.5/2)
- 3-4. Press the [▶ENT] button to return to the previous mode.

● Adjusting the treble

This adjustment can be performed only when the Z-Enhancer Plus is set to “CUSTOM”.

- 2-1. Select “**TREBLE**”.
- 3-1. Press the [ENT] button.
- 3-2. Press the [◀◀] or [▶▶] button to select as following order.
“**T<G 0>**” ↔ “**T<F 10k>**”
- 3-3. Turn the [ROTARY] knob to adjust the gain, the F (center frequency) and the Q.
T<G 0> : The factory default setting is “0”.
(Adjustment range: +7 to -7)
T<F 10k>: The factory default setting is “10k”.
(Adjustment range: 10k/12.5k/
15k/17.5k)
- 3-4. Press the [ENT] button to return to the previous mode.

● Adjusting the balance

- 2-1. Select “**BALANCE**”.
- 3-1. Turn the [ROTARY] knob to adjust the balance of the right and left speakers.
* The factory default setting is “**CENTER**” (center). (Adjustment range: RIGHT12 to LEFT12 (right 12 to left 12))

● Adjusting the fader

- 2-1. Select “**FADER**”.
- 3-1. Turn the [ROTARY] knob to adjust the balance of the rear and front speakers.
* The factory default setting is “**CENTER**” (center). (Adjustment range: FRONT12 to REAR12 (front 12 to rear 12))

● Adjusting the non fader output volume

You can adjust the volume output from the unit's non fader output terminal.

- 2-1. Select “**NF VOL**”.
- 3-1. Turning the [ROTARY] knob clockwise increases the output volume; turning it counterclockwise decreases the output volume.
* The factory default setting is “0”.
(Adjustment range: -6 to +6)

Note:

- During SOUND adjustment mode, if no operation is performed for more than 10 seconds, this mode can be cancelled and return to previous mode.

Setting the MAGNA BASS EXTEND

The MAGNA BASS EXTEND does not adjust the low frequencies like the normal sound adjustment function, but emphasizes the deep bass frequencies to provide you with a dynamic sound.

* The factory default setting is “**OFF**” (off).

1. Press and hold the [SOUND] button for 1 second or longer to turn on the MAGNA BASS EXTEND effect. “**M-B EX**” appears in the display for 2 seconds.
2. Press and hold the [SOUND] button for 1 second or longer to turn off the MAGNA BASS EXTEND effect. “**M-B OFF**” appears in the display for 2 seconds.

Radio Operations

Listening to the radio

1. Press the [SRC] button and select the radio mode. The frequency appears in the display.
2. Press the [BND] button and select the radio band. Each time the button is pressed, the radio reception band changes in the following order:
F1 (FM1) → F2 (FM2) → F3 (FM3) → AM → F1 (FM1)...
3. Press the [◀◀] or [▶▶] button to tune in the desired station.

Tuning

There are 3 types of tuning mode available, seek tuning, manual tuning and preset tuning.

Seek tuning

1. Press the [BND] button and select the desired band (FM or AM).
 - * If "MANU" is lit in the display, press and hold the [BND] button for 1 second or longer. "MANU" in the display goes off and seek tuning is now available.
2. Press the [◀◀] or [▶▶] button to automatically seek a station.

When the [▶▶] button is pressed, the station is sought in the direction of higher frequencies; if the [◀◀] button is pressed, the station is sought in the direction of lower frequencies.

Manual tuning

There are 2 ways available: Quick tuning and step tuning.

When you are in the step tuning mode, the frequency changes one step at a time. In the quick tuning mode, you can quickly tune the desired frequency.

1. Press the [BND] button and select the desired band (FM or AM).
 - * If "MANU" is not lit in the display, press and hold the [BND] button for 1 second or longer. "MANU" is lit in the display and manual tuning is now available.
2. Tune into a station.

● Quick tuning

Press and hold the [◀◀] or [▶▶] button for 1 second or longer to tune in a station.

● Step tuning

Press the [◀◀] or [▶▶] button to manually tune in a station.

Recalling a preset station

A total of 24 preset positions (6-FM1, 6-FM2, 6-FM3, 6-AM) exists to store individual radio stations in memory. Press the corresponding [DIRECT] button to recall the stored radio frequency automatically.

1. Press the [BND] button and select the desired band (FM or AM).
2. Press the corresponding [DIRECT] button to recall the stored station.

Note:

- Press and hold one of the [DIRECT] buttons for 2 seconds or longer to store that station into preset memory.

Manual memory

1. Select the desired station with seek tuning or manual tuning.
2. Press and hold one of the [DIRECT] buttons for 2 seconds or longer to store the current station into preset memory.

Auto store

Auto store is a function for storing up to 6 stations that are automatically tuned in sequentially. If 6 receivable stations cannot be received, a previously stored station remains unoverwritten at the memory position.

1. Press the [BND] button and select the desired band (FM or AM).
2. Press and hold the [ENT] button for 2 seconds or longer. The stations with good reception are stored automatically to the preset channels.

Preset scan

Preset scan receives the stations stored in preset memory in order. This function is useful when searching for a desired station in memory.

1. Press the [▶**ENT**] button.
2. When a desired station is tuned in, press the [▶**ENT**] button again to continue receiving that station.

Note:

- Be careful not to press and hold the [▶**ENT**] button for 2 seconds or longer, otherwise the auto store function is engaged and the unit starts storing stations.

Instant station recall (ISR)

Instant station recall is a special radio preset that instantly accesses a favorite radio station at a touch of a button. The ISR function even operates with the unit in other modes.

● ISR memory

1. Select the station that you wish to store in ISR memory.
2. Press and hold the [ISR] button for 2 seconds or longer.

● Recalling a station with ISR

In any mode, press the [ISR] button to turn on the radio function and tune the selected radio station. "ISR" appears in the display. Press the [ISR] button again to return to the previous mode.

CD/MP3/WMA Operations

MP3/WMA

What is MP3?

MP3 is an audio compression method and classified into audio layer 3 of MPEG standards. This audio compression method has penetrated into PC users and become a standard format.

This MP3 features the original audio data compression to about 10 percent of its initial size with a high sound quality. This means that about 10 music CDs can be recorded on a CD-R disc or CD-RW disc to allow a long listening time without having to change CDs.

What is WMA?

WMA is the abbreviation of Windows Media Audio, an audio file format developed by Microsoft Corporation.

Notes:

- If you play a file with DRM (Digital Rights Management) for WMA remaining ON, no audio is output (The WMA indicator blinks).
- Windows Media™, and the Windows® logo are trademarks, or registered trademarks of Microsoft Corporation in the United States and/or other countries.

● To disable DRM (Digital Rights Management)

1. When using Windows Media Player 9/10/11, click on TOOL → OPTIONS → MUSIC RECORD tab, then under Recording settings, unclick the Check box for RECORD PROTECTED MUSIC. Then, reconstruct files.

Personally constructed WMA files are used at your own responsibility.

Precautions when creating MP3/WMA file

● Usable sampling rates and bit rates

1. MP3: Sampling rate 8 kHz-48 kHz,
Bit rate: 8 kbps-320 kbps / VBR
2. WMA: Bit rate 48 kbps-192 kbps

● File extensions

1. Always add a file extension “.MP3” or “.WMA” to MP3 or WMA file by using single byte letters. If you add a file extension other than specified or forget to add the file extension, the file cannot be played.
2. Files without MP3/WMA data will not play. The indication “--:--” appears in the play time display if you attempt to play files without MP3/WMA data.

● Logical format (File system)

1. When writing MP3/WMA file on a CD-R disc or CD-RW disc, please select “ISO9660 level 1, 2 or JOLIET or Romeo” as the writing software format. Normal play may not be possible if the disc is recorded on another format.
2. The folder name and file name can be displayed as the title during MP3/WMA play but the title must be within 64 single byte alphabetical letters and numerals (including an extension).
3. Do not affix a name to a file inside a folder having the same name.

● Number of files or folders

1. Up to 256 files can be recognized per folder. Up to 578 files can be played.
2. Tracks are played in the order that they were recorded onto a disc. (Tracks might not always be played in the order displayed on the PC.)
3. Some noise may occur depending on the type of encoder software used while recording.

Disc-In-Play function

As long as the ignition key is turned to the ON or ACC position, this function allows you to turn the power to the unit and start playing the disc automatically when the disc is inserted even if the power is not turned on.

⚠ CAUTION

- Do not try to put your hand or fingers in the disc insertion slot. Also never insert foreign objects into the slot.
- Do not insert discs where adhesive comes out from cellophane tape or a rental CD label, or discs with marks where cellophane tape or rental CD labels were removed. It may be impossible to extract these discs from the unit and they may cause the unit to break down.

Ejecting a CD

1. Press the [▲] to eject the CD. Take it out from the ejected position. "EJECT" appears in the display.

Notes:

- If a CD (12 cm) is left in the ejected position for 15 seconds, the CD is automatically reloaded. (Auto reload)
- If you force a CD into before auto reloading, this can damage the CD.

Listening to a disc already loaded in the unit

Press the [SRC] button to select the CD/MP3/WMA mode.

When the unit enters the CD/MP3/WMA mode, play starts automatically.

If there is no disc loaded, the indication "NO DISC" appears in the display.



The mode changes each time the [SRC] button is pressed.

Radio → CD/MP3/WMA → AUX → Radio ...

Loading a CD

1. Insert a CD into the centre of the CD SLOT with the labeled side facing up. "LOADING" appears in the display, the CD enters into the slot, and the play starts.

Notes:

- Never insert foreign objects into the CD SLOT.
- If the CD is not inserted easily, there may be another CD in the mechanism or the unit may require service.
- Discs not bearing the  or  mark and CD-ROMs cannot be played by this unit.
- Some CDs recorded in CD-R/CD-RW mode may not be usable.

Pausing play

1. Press the [▶||] button to pause play. "PAUSE" appears in the display.
2. To resume CD play, press the [▶||] button again.

Displaying CD titles

This unit can display title data for CD-text/MP3/WMA disc and user titles input with this unit.

1. Each time you press the [DISP] button to change the title display.

● CD-TEXT disc

Track → Disc → Artist → Track ...

● MP3/WMA disc

Track → Folder → Title → Album → Artist → Track ...

Notes:

- If the CD playing is not a CD-text CD or no user title has been input, "NO TITLE" appears in the display.
- If MP3/WMA disc is not input TAG, "NO TITLE" appears in the display.
- For MP3, supports ID3 Tags V2.3 / 2.2 / 1.1 / 1.0.
- Tag displays give priority to V2.3 / 2.2.
- In the case of album Tags for WMA, the information written into the extension header is displayed.
- ISO8859-1, ASCII, S-JIS characters can be displayed in Tags.
UNKNOW characters can be turned to ISO8859-1 characters.
- Titles up to 32 bytes can be displayed in CD/MP3/WMA mode.

CD/MP3/WMA Operations

Selecting a track

● Track-up

1. Press the [▶▶] button to move ahead to the beginning of the next track.
2. Each time you press the [▶▶] button, the track advances ahead to the beginning of the next track.

● Track-down

1. Press the [◀◀] button to move back to the beginning of the current track.
2. Press the [◀◀] button twice to move back to the beginning of the previous track.

Fast-forward/fast-backward

● Fast-forward

1. Press and hold the [▶▶] button for 1 second or longer.

● Fast-backward

1. Press and hold the [◀◀] button for 1 second or longer.

* For MP3/WMA discs, it takes some time until the start of searching and between tracks. In addition, the playing time may have a margin of error.

Folder Select

This function allows you to select a folder containing MP3/WMA files and start playing from the first track in the folder.

1. Press the [UP] or [DN] button.
Press the [UP] button to move the next folder. Press the [DN] button to move the previous folder.
2. To select a track, press the [◀◀] or [▶▶] button.

Other various play functions

● Scan play

This function allows you to locate and play the first 10 seconds of all the tracks recorded on a disc.

1. Press the [SCN] button to perform scan play. "TRK SCN" appears in the display for 2 seconds.
* Scan play starts from the next track after the track currently being played.

● Folder scan play

This function allows you to locate and play the first 10 seconds of the first track of all the folders on an MP3/WMA disc.

1. Press and hold the [SCN] button for 1 second or longer to perform folder scan play. "ALL SCN" appears in the display for 2 seconds.
* Folder scan play starts from the next folder after the folder currently being played.

● Repeat play

This function allows you to play the current track repeatedly.

1. Press the [RPT] button to perform repeat play.
"TRK RPT" appears in the display for 2 seconds.

● Folder repeat play

This function allows you to play a track currently being played in the MP3/WMA folder repeatedly.

1. Press and hold the [RPT] button for 1 second or longer to perform folder repeat play.
“ALL RPT” appears in the display for 2 seconds.

● Random play

This function allows you to play all tracks recorded on a disc in a random order.

1. Press the [RDM] button to perform random play.
“TRK RDM” appears in the display for 2 seconds.

● Folder random play

This function allows you to play all the tracks of all the folders recorded on an MP3/WMA disc in a random order.

1. Press and hold the [RDM] button for 1 second or longer to perform folder random play.
“ALL RDM” appears in the display for 2 seconds.

● To cancel play

1. Press the operating button previously selected.
 - * The various play mode is canceled and the various play off mode appears in the display for 2 seconds.
 - * When the error display indication “- -: -” appears in the display, the various play (Scan/Repeat/Random) functions can be canceled in play mode.

Operations Common to Each Mode

To change adjustment setting

1. Press and hold the [DISP] button for 1 second or longer to switch to the adjustment selection display.
2. Press the [◀◀] or [▶▶] button to select the "item name".
 "CLOCK" ↔ "SETTINGS" ↔ "SCRN SVR"
 ↔ "SCROLL" ↔ "DIMMER" ↔ "TEL-SP"
 ↔ "TEL-SW"
 * The adjustment item name will be displayed for 2 seconds before showing the desired value.
3. Turn the [ROTARY] knob to select the "desired setting value".
 * In the case of display blinking "ENT", you can press the [ENT] button to adjust the setting value.
 * After completing settings, press the [DISP] button to return to the previous mode.

● Setting the clock

- 2-1. Select "CLOCK".
- 3-1. Press the [ENT] button
- 3-2. Press the [◀◀] or [▶▶] button to select the hour or the minute.
- 3-3. Turn the [ROTARY] knob to set the correct time.
 * The clock is displayed in 12-hour format.
- 3-4. Press the [ENT] button to store the time into memory and return to the previous mode.

Note:

- You cannot set the clock when it is displayed with only the ignition on. If you drain or remove the car's battery or take out this unit, the clock is reset. While setting the clock, if another button or operation is selected, the clock set mode is canceled.

● Displaying the settings

The number of indicator of this unit decreases, you can see the state of current settings at any operation mode.

- 2-1. Select "SETTINGS".
- 3-1. Turn the [ROTARY] knob to display the state of current settings.
 * When the setting is selected, after 1 second the current state will be displayed.

For example: after 1 second,

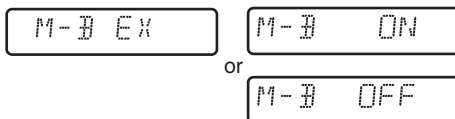

● Turning the screen saver function on or off

This unit is provided with the screen saver function which allows you to show various kinds of patterns and characters in the operation status indication area of the display in a random order. You can turn on or off this function. If the button operation is performed with the screen saver function on, the operation display corresponding to the button operation is shown for about 30 seconds and the display returns to the screen saver display.

- * The factory default setting is "ON".
- 2-1. Select "SCRN SVR".
 - 3-1. Turn the [ROTARY] knob to select "ON" or "OFF".

Operations Common to Each Mode

● Setting the method for title scroll

Set how to scroll in CD-TEXT, MP3/WMA title.

* The factory default setting is “ON”.

2-1. Select “**SCROLL**”.

3-1. Turn the [ROTARY] knob to select “ON” or “OFF”.

• **ON:**

To scroll automatically.

• **OFF:**

To scroll just 1 time.

● Setting the dimmer control

You can set the dimmer control “ON” or “OFF”.

* The factory default setting is “ON”.

2-1. Select “**DIMMER**”.

3-1. Turn the [ROTARY] knob to select “ON” or “OFF”.

● Setting the car speaker output for the cellular phone

* The factory default setting is “RIGHT”.

* To output the telephone calls, set the cellular phone interrupt to “ON”.

When the AUX input jack is used to connect an AUX BLUETOOTH BB (BLT370) (sold separately):

2-1. Select “**TEL-SP**”.

3-1. Turn the [ROTARY] knob to select “RIGHT” or “LEFT”.

• **RIGHT:**

Telephone calls can be heard on the front right speaker connected to this unit.

• **LEFT:**

Telephone calls can be heard on the front left speaker connected to this unit.

● Cellular phone interrupt setting

If you connect this unit and your cellular phone with a separately sold cable, you can listen to your telephone calls on your car speakers.

* The factory default setting is “OFF”.

When the AUX input jack is used to connect an AUX BLUETOOTH BB (BLT370) (sold separately):

2-1. Select “**TEL-SW**”.

3-1. Turn the [ROTARY] knob to select the setting. Each time you turn the [ROTARY] knob, the setting changes in the following order:

“OFF” ↔ “ON” ↔ “MUTE”

• **OFF:**

This unit continues normal operation even when the cellular phone is used.

• **ON:**

You can listen to your telephone calls from the speakers connected to this unit.

* When listening to your calls on your car speakers, you can adjust the volume by turning the [ROTARY] knob.

• **MUTE:**

The sound from this unit is muted during telephone calls.

Note:

• If connecting a hands-free kit, please ensure the setting is ON to receive the telephone audio through the system.

AUX function

This system has an external input jack on the front panel so you can listen to sounds and music from external devices connected to this unit.

● Selecting AUX IN sensitivity

Make the following settings to select the sensitivity when sounds from external devices connected to this unit are difficult to hear even after adjusting the volume.

* The factory default setting is “MID”.

1. Press and hold the [DISP] button for 1 second or longer.

2. Select “**AUX SENS**”.

3. Turn the [ROTARY] knob to select “HIGH”, “MID” or “LOW”.

Note:

• When AUX mode is selected, AUX IN sensitivity can be set.

7. TROUBLESHOOTING

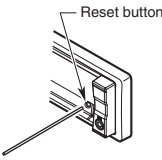
	Problem	Cause	Measure
General	Power does not turn on. (No sound is produced.)	Fuse is blown.	Replace with a fuse of the same amperage. If the fuse blows again, consult your store of purchase.
		Incorrect wiring.	Consult your store of purchase.
	No sound output when operating the unit with amplifiers or power antenna attached.	Power antenna lead is shorted to ground or excessive current is required for remote-on the amplifiers or power antenna.	<ol style="list-style-type: none"> 1. Turn the unit off. 2. Remove all wires attached to the power antenna lead. Check each wire for a possible short to ground using an ohm meter. 3. Turn the unit back on. 4. Reconnect each amplifier remote wire to the power antenna lead one by one. If the amplifiers turn off before all wires are attached, use an external relay to provide remote-on voltage (excessive current required).
	Nothing happens when buttons are pressed. Display is not accurate.	The microprocessor has malfunctioned due to noise, etc.	Turn off the power, then press the [RELEASE] button and remove the DCP. Press the reset button for about 2 seconds with a thin rod. 
		DCP or main unit connectors are dirty.	Wipe the dirt off with a soft cloth moistened with cleaning alcohol.
	No sound heard	The speaker protection circuit is operating.	<ol style="list-style-type: none"> 1. Turn down sound volume. Function can also be restored by turning the power off and on again. (Speaker volume is reduced automatically when the speaker protection circuit operates). 2. If the sound is muted again, consult our service department.
CD/MP3/WMA	No sound heard	MP3/WMA files are absent in a disc.	Write MP3/WMA files onto the disc properly.
		Files are not recognized as an MP3/WMA file.	Use MP3/WMA files encoded properly.
		File system is not correct.	Use ISO9660 level 1, 2 or JOLIET or Romeo file system.
	Sound skips or is noisy.	Compact disc is dirty.	Clean the compact disc with a soft cloth.
		Compact disc is heavily scratched or warped.	Replace with a compact disc with no scratches.
	Sound is cut or skipped. Noise is generated or noise is mixed with sound.	MP3/WMA files are not encoded properly.	Use MP3/WMA files encoded properly.
	Sound is bad directly after power is turned on.	Water droplets may form on the internal lens when the car is parked in a humid place.	Let dry for about 1 hour with the power on.
Wrong filename	File system is not correct.	Use ISO9660 level 1, 2 or JOLIET or Romeo file system.	

8. ERROR DISPLAYS

If an error occurs, one of the following displays is displayed.
Take the measures described below to eliminate the problem.

	Error Display	Cause	Measure
CD/MP3/WMA	ERROR 2	A CD is caught inside the CD deck and is not ejected.	This is a failure of CD deck's mechanism and consult your store of purchase.
	ERROR 3	A CD cannot be played due to scratches, etc.	Replace with a non-scratched, non-warped-disc.
	ERROR 6	A CD is loaded upside-down inside the CD deck and does not play.	Eject the disc then reload it properly.

If an error display other than the ones described above appears, press the reset button. If the problem persists, turn off the power and consult your store of purchase.

9. SPECIFICATIONS

FM Tuner

Frequency Range: 87.9 MHz to 107.9 MHz
 Usable Sensitivity: 9 dBf
 50dB Quieting Sensitivity: 15 dBf
 Alternate Channel Selectivity: 70 dB
 Stereo Separation (1 kHz): 35 dB
 Frequency Response (± 3 dB): 30 Hz to 15 kHz

AM Tuner

Frequency Range: 530 kHz to 1710 kHz
 Usable Sensitivity: 25 μ V

CD Player

System: Compact disc digital audio system
 Usable Discs: Compact disc
 Frequency Response (± 1 dB): 5 Hz to 20 kHz
 Dynamic Range (1 kHz): 85 dB
 Harmonic Distortion: 0.01%

Audio

Maximum Power Output: 200 W (50 W \times 4 ch)
 Bass Control Action (100 Hz): +14 dB, -14 dB
 Treble Control Action (10 kHz): +14 dB, -14 dB
 Line Output Level (CD 1 kHz): 1.8 V

Note:

- Specifications and design are subject to change without notice for further improvement.

General

Power Supply Voltage:
 14.4 V DC (10.8 to 15.6 V allowable), negative ground
 Current Consumption: Less than 15 A
 Speaker Impedance: 4 Ω (4 Ω to 8 Ω allowable)
 Weight / Source unit: 2.57 lb. (1.14 kg)
 Dimensions / Source unit:
 7" (Width) \times 2" (Height) \times 6-1/8" (Depth)
 [178 (W) \times 50 (H) \times 155 (D) mm]

Power Output :

20 W RMS x 4 Channels at 4
 and 1 % THD+N

Signal to Noise Ratio:

87 dBA (reference: 1 W into 4)



Clarion Co., Ltd.

All Rights Reserved. Copyright © 2007: Clarion Co., Ltd.
Printed in China / Imprimé en Chine / Impreso en China

PE-3049B
280-8589-00

2007/12