

Operation Manual

DVD AV RECEIVER

AVH-P5950DVD

SUPER  **TUNER III D**

English

Thank you for buying this Pioneer product.

Please read through these operating instructions so you will know how to operate your model properly. *After you have finished reading the instructions, keep this manual in a safe place for future reference.*



Be sure to read this

- Playable discs **8**
- DVD video disc region numbers **8**
- When an operation is prohibited **12**

01 Precautions

IMPORTANT SAFEGUARDS **6**

- To ensure safe driving **6**
 - When using a display connected to REAR MONITOR OUTPUT **7**
- To avoid battery exhaustion **7**

02 Before You Start

- About this unit **8**
 - Playable discs **8**
 - DVD video disc region numbers **8**
- About this manual **9**
- Visit our website **9**
- Features **9**
 - About WMA **10**
 - About MP3 **10**
 - About AAC **10**
 - About DivX **11**
- To protect the LCD screen **11**
- For viewing LCD comfortably **11**
 - Changing the wide screen size **11**
 - Changing the picture adjustment **11**
- What the marks on DVDs indicate **11**
 - When an operation is prohibited **12**
- Protecting your unit from theft **12**
 - Removing the front panel **12**
 - Attaching the front panel **12**
- Resetting the microprocessor **12**
- Feature demo mode **13**
- Use and care of the remote control **13**
 - Installing the battery **13**
 - Using the remote control **14**

03 Operating this unit

- What's What **15**
 - Head unit **15**
 - Remote control **17**
- Basic Operations **20**
 - Power ON/OFF **20**
 - Selecting a source **20**
 - Adjusting the volume **21**
 - Touch panel key basic operation **21**
 - Opening and closing the LCD panel **22**
- Radio **23**
 - Basic Operations **23**
 - Storing and recalling broadcast frequencies **24**
 - Introduction of advanced operations **24**
 - Storing the strongest broadcast frequencies **24**
 - Tuning in strong signals **25**
- Built-in DVD player **25**
 - Basic Operations **25**
 - Basic playback controls **26**
 - Switching the media file type **27**
 - Operating the DVD menu **27**
 - PBC playback **28**
 - Playing DivX® VOD content **28**
 - Skipping back or forward to another title **28**
 - Selecting the play mode **28**
 - CM skip/CM back **29**
 - Resume playback (Bookmark) **29**
 - Searching for the part you want to play **29**
 - Changing audio language during playback (Multi-audio) **30**
 - Changing the subtitle language during playback (Multi-subtitle) **30**

- Changing the viewing angle during playback (Multi-angle) **30**
- Frame-by-frame playback **31**
- Slow motion playback **31**
- Return to the specified scene **31**
- Automatic playback of DVDs **31**
- Text information **32**
- Selecting tracks from the track list **32**
- Selecting files from the file name list **33**
- Selecting titles from the title list **33**
- Introduction of advanced operations **33**
- Repeating play **33**
- Playing tracks in random order **34**
- Scanning tracks or folders **34**
- Selecting audio output **34**
- Using compression **35**
- Playing songs on iPod **35**
 - Basic Operations **35**
 - Browsing for a song **36**
 - Displaying text information on iPod **36**
 - Repeating play **37**
 - Playing songs in a random order (shuffle) **37**
 - Playing all songs in a random order (shuffle all) **37**
 - Pausing a song **37**
 - Changing audiobook speed **37**
 - Playing video **37**
- Audio Adjustments **38**
 - Introduction of audio adjustments **38**
 - Using balance adjustment **38**
 - Using the equalizer **38**
 - Adjusting loudness **40**
 - Using subwoofer output **40**
 - Boosting the bass **40**
 - Using the high pass filter **40**
 - Adjusting source levels **41**
 - Staging for car environment **41**
- Setting up the DVD player **42**
 - Introduction of DVD setup adjustments **42**
 - Setting the subtitle language **42**
 - Setting the audio language **42**
 - Setting the menu language **43**
 - Switching the assist subtitle on or off **43**
 - Setting the angle icon display **43**
 - Setting the aspect ratio **43**
 - Setting the parental lock **44**
 - Setting the DivX subtitle file **45**
 - Displaying your DivX® VOD registration code **45**
 - Setting for digital output **45**
 - Setting remote control code type **46**
- Initial Settings **46**
 - Adjusting initial settings **46**
 - Switching the auxiliary setting **47**
 - Setting the FM tuning step **47**
 - Setting the AM tuning step **47**
 - Selecting the OSD color **47**
 - Selecting the illumination color **47**
 - Setting the rear output and subwoofer controller **48**
 - Switching the sound muting/attenuation **48**
 - Switching the warning tone **48**
 - Setting the TV signal **49**
 - Entering PIN code for Bluetooth wireless connection **49**
 - Correcting distorted sound **49**
 - Resetting the audio functions **49**
- Other Functions **50**
 - Introduction of system adjustments **50**
 - Changing the wide screen mode **50**

- Changing the picture adjustment **51**
- Selecting the background display **52**
- Setting the AV input **52**
- Setting the clock **52**
- Setting for rear view camera (back up camera) **53**
- Adjusting the LCD panel slide position **53**
- Setting the automatic open function **54**
- Switching the iPod charge setting **54**
- Adjusting the response positions of the touch panels (Touch Panel Calibration) **54**
- Using the AUX source **55**
- Using the PGM button **56**

04 Available accessories

Playing songs on USB portable audio player/
USB memory **57**

- Basic Operations **57**
- Pausing compressed audio playback **57**
- Introduction of advanced operations **57**
- Displaying text information of an audio file **58**
- Selecting files from the file name list **58**

Bluetooth Audio **58**

- Basic Operations **58**
- Pausing playback **59**
- Introduction of advanced operations **59**
- Connecting a Bluetooth audio player **59**
- Disconnecting a Bluetooth audio player **60**

- Displaying BD (Bluetooth Device) address **60**

Bluetooth Telephone **60**

- Basic Operations **60**
- Setting up for hands-free phoning **61**
- Making a phone call **62**
- Taking a phone call **62**
- Introduction of advanced operations **62**
- Connecting a cellular phone **62**
- Disconnecting a cellular phone **63**
- Registering connected cellular phone **63**
- Deleting a registered phone **63**
- Connecting to a registered cellular phone **64**
- Using the Phone Book **64**
- Using the Call History **66**
- Using preset numbers **66**
- Making a call by entering phone number **67**

- Clearing memory **67**
- Setting the automatic answering **67**
- Setting the automatic rejecting **67**
- Switching the ring tone **67**
- Echo canceling and noise reduction **67**
- Displaying BD (Bluetooth Device) address **68**

Multi-CD Player **68**

- Basic Operations **68**
- Selecting a disc **69**
- Pausing CD playback **69**
- Introduction of advanced operations **69**
- Using CD TEXT functions **69**

DVD Player **70**

- Basic Operations **70**
- Turning the DVD player on or off **71**

- Selecting a disc **71**
- Selecting a folder **71**
- Pausing disc playback **71**
- Introduction of advanced operations **71**
- TV tuner **73**
 - Basic Operations **73**
 - Storing and recalling broadcast stations **73**
 - Introduction of advanced operations **74**
 - Storing the strongest broadcast stations sequentially **74**
 - Selecting the area group **74**
- Digital Signal Processor **75**
 - Introduction of DSP adjustments **75**
 - Using the sound field control **75**
 - Using the position selector **76**
 - Using balance adjustment **76**
 - Adjusting source levels **77**
 - Using the dynamic range control **77**
 - Using the down-mix function **77**
 - Using the direct control **78**
 - Using the Dolby Pro Logic II **78**
 - Setting the speaker setting **79**
 - Adjusting the speaker output levels **80**
 - Selecting a cross-over frequency **80**
 - Adjusting the speaker output levels using a test tone **81**
 - Using the time alignment **81**
 - Using the equalizer **82**
 - Using the auto-equalizer **84**
 - Auto TA and EQ (auto-time alignment and auto-equalizing) **84**
- Understanding auto TA and EQ error messages **90**
- Handling guideline of discs and player **92**
- DVD discs **92**
- DVD-R/DVD-RW discs **92**
- AVCHD recorded discs **93**
- CD-R/CD-RW discs **93**
- Dual Discs **93**
- Compressed audio files on the disc **93**
 - Example of a hierarchy **94**
 - Compressed audio compatibility **94**
- DivX video files **94**
 - DivX compatibility **95**
- About handling the iPod **95**
 - About iPod settings **95**
- Using the display correctly **95**
 - Handling the display **95**
 - Liquid crystal display (LCD) screen **96**
 - Keeping the display in good condition **96**
 - Small fluorescent tube **96**
- Language code chart for DVD **97**
- Terms **98**
- Specifications **101**

● Index **103**

● Additional Information

- Troubleshooting **87**
- Error messages **89**

IMPORTANT SAFEGUARDS

Please read all of these instructions regarding your display and retain them for future reference.

- 1 **Read this manual fully and carefully before operating your display.**
- 2 **Keep this manual handy as a reference for operating procedures and safety information.**
- 3 **Pay close attention to all warnings in this manual and follow the instructions carefully.**
- 4 **Do not allow other persons to use this system until they have read and understood the operating instructions.**
- 5 **Do not install the display where it may (i) obstruct the driver's vision, (ii) impair the performance of any of the vehicle's operating systems or safety features, including air bags, hazard lamp buttons or (iii) impair the driver's ability to safely operate the vehicle.**
- 6 **Do not operate this display if doing so in any way will divert your attention from the safe operation of your vehicle. Always observe safe driving rules and follow all existing traffic regulations. If you experience difficulty in operating the system or reading the display, park your vehicle in a safe location and make necessary adjustments.**
- 7 **Please remember to wear your seat belt at all times while operating your vehicle. If you are ever in an accident, your injuries can be considerably more severe if your seat belt is not properly buckled.**
- 8 **Never use headphones while driving.**
- 9 **To promote safety, certain functions are disabled unless the parking brake is on, and the vehicle is not in motion.**
- 10 **Never set the volume of your display so high that you cannot hear outside traffic and emergency vehicles.**



WARNING

- **Do not attempt to install or service your display by yourself. Installation or servicing of the display by persons without training and experience in electronic equipment and automotive accessories may be dangerous and could expose you to the risk of electric shock or other hazards.** 

To ensure safe driving



WARNING

- **LIGHT GREEN LEAD AT POWER CONNECTOR IS DESIGNED TO DETECT PARKED STATUS AND MUST BE CONNECTED TO THE POWER SUPPLY SIDE OF THE PARKING BRAKE SWITCH. IMPROPER CONNECTION OR USE OF THIS LEAD MAY VIOLATE APPLICABLE LAW AND MAY RESULT IN SERIOUS INJURY OR DAMAGE.**
- To avoid the risk of damage and injury and the potential violation of applicable laws, this unit is not for use with a video screen that is visible to the driver.
- To avoid the risk of accident and the potential violation of applicable laws, the front DVD or TV (sold separately) feature should never be used while the vehicle is being driven. Also, rear displays should not be in a location where it is a visible distraction to the driver.
- In some countries or states the viewing of images on a display inside a vehicle even by persons other than the driver may be illegal. Where such regulations apply, they must be obeyed and this unit's DVD features should not be used.

Precautions

When you attempt to watch a DVD, Video CD or TV while driving, the warning **Viewing of front seat video source while driving is strictly prohibited.** will appear on the front display.

To watch a DVD, Video CD or TV on the front display, park your vehicle in a safe place and apply the parking brake.

When using a display connected to REAR MONITOR OUTPUT

This unit's **REAR MONITOR OUTPUT** is for connection of a display to enable passengers in the rear seats to watch the DVD or TV.



WARNING

NEVER install the rear display in a location that enables the driver to watch the DVD or TV while driving. 

To avoid battery exhaustion

Be sure to run the vehicle engine while using this unit. Using this unit without running the engine can result in battery drainage.

- When no power is supplied to this unit because of a replacement of the vehicle battery or for some similar reason, the microcomputer of this unit is returned to its initial condition. We recommend that you transcribe the audio adjustment data.



WARNING

Do not use with vehicles that do not feature an ACC position. 

About this unit

⚠ CAUTION

- Do not allow this unit to come into contact with liquids. Electrical shock could result. Also, this unit damage, smoke, and overheat could result from contact with liquids.
- “CLASS 1 LASER PRODUCT”
This product contains a laser diode of higher class than 1. To ensure continued safety, do not remove any covers or attempt to gain access to the inside of the product. Refer all servicing to qualified personnel.
- Keep this manual handy as a reference for operating procedures and precautions.
- Always keep the volume low enough so that you can hear sounds from outside the vehicle.
- Protect this unit from moisture.
- If the battery is disconnected or discharged, the preset memory will be erased and must be reprogrammed.
- If this unit does not operate properly, contact your dealer or nearest authorized Pioneer Service Station.

Playable discs

DVD, Video CD and CD discs that display the logos shown below can be played back on this player.

DVD video



Video CD



CD



Notes

- DVD** is a trademark of DVD Format/Logo Licensing Corporation.
- This player can only play back discs bearing the marks shown above.

DVD video disc region numbers

DVD video discs that have incompatible region numbers cannot be played on this player. The region number of the player can be found on the bottom of this unit.

The illustration below shows the regions and corresponding region numbers.



Before You Start

About this manual

This unit features a number of sophisticated functions ensuring superior reception and operation. All the functions have been designed for the easiest possible use, but many are not self-explanatory. This operation manual will help you benefit fully from this unit's potential and to maximize your listening enjoyment. We recommend that you familiarize yourself with the functions and their operation by reading through the manual before you begin using this unit. It is especially important that you read and observe **WARNINGs** and **CAUTIONs** in this manual. 

Visit our website

Visit us at the following site:



- We offer the latest information about Pioneer Corporation on our website. 

Features

Touch panel key operation

It is possible to operate this unit by using touch panel key.

DVD-R/RW compatibility

It is possible to play back DVD-R/RW discs recorded with the video format and Video Recording format. (Refer to *DVD-R/DVD-RW discs* on page 92.)

Video CDs featuring PBC compatibility

It is possible to play back Video CDs featuring PBC (playback control).

WMA, MP3 and AAC compatibility

Refer to *Compressed audio compatibility* on page 94.

DivX® video compatibility

Refer to *DivX compatibility* on page 95.

Dolby Digital/DTS compatibility

When using this unit with a Pioneer multi-channel processor, you can enjoy the atmosphere and excitement provided by DVD movie and music software featuring 5.1 channel recordings.

- Manufactured under license from Dolby Laboratories. "Dolby", "Pro Logic", and the double-D symbol are trademarks of Dolby Laboratories.



- "DTS" and "DTS Digital Out" are registered trademarks of DTS, Inc.



iPod® compatibility

This unit can control and listen to songs on an iPod.

- This unit supports only an iPod with Dock Connector.
- This unit controls the iPod listed below.
 - iPod fifth generation (software version 1.2 or later)
 - iPod nano (second generation) (software version 1.0.2 or later)
 - iPod nano (software version 1.2 or later)
 - iPod photo (software version 1.2.1 or later)

Before You Start

- iPod (click wheel) (software version 3.1.1 or later)
- iPod mini (software version 1.4.1 or later)
- iPod (dock connector) (software version 2.3 or later)

To obtain maximum performance, we recommend that you use the latest version of the iPod software.

- Operations may vary depending on the software version of iPod.
- iPod is a trademark of Apple Computer, Inc., registered in the U.S. and other countries.

Note

This product incorporates copyright protection technology that is protected by method claims of certain U.S. patents and other intellectual property rights owned by Macrovision Corporation and other rights owners. Use of this copyright protection technology must be authorized by Macrovision Corporation, and is intended for home and other limited viewing uses only unless otherwise authorized by Macrovision Corporation. Reverse engineering or disassembly is prohibited.

About WMA



The Windows Media™ logo printed on the box indicates that this unit can play back WMA data.

WMA is short for Windows Media Audio and refers to an audio compression technology that is developed by Microsoft Corporation. WMA data can be encoded by using Windows Media Player version 7 or later.

- Windows Media and the Windows logo are trademarks or registered trademarks of Microsoft Corporation in the United States and/or other countries.
- This unit may not operate correctly depending on the application used to encode WMA files.

About MP3

Supply of this product only conveys a license for private, non-commercial use and does not convey a license nor imply any right to use this product in any commercial (i.e. revenue-generating) real time broadcasting (terrestrial, satellite, cable and/or any other media), broadcasting/streaming via internet, intranets and/or other networks or in other electronic content distribution systems, such as pay-audio or audio-on-demand applications. An independent license for such use is required. For details, please visit <http://www.mp3licensing.com>.

About AAC

AAC is short for Advanced Audio Coding and refers to an audio compression technology standard used with MPEG 2 and MPEG 4. Several applications can be used to encode AAC files, but file formats and extensions differ depending on the application which is used to encode.

This unit plays back AAC files encoded by iTunes® version 6.0.5.

- iTunes is a trademark of Apple Computer, Inc., registered in the U.S. and other countries.

Before You Start

About DivX



DivX is a compressed digital video format created by the DivX® video codec from DivX, Inc. This unit can play DivX video files recorded on CD-R/RW/ROM and DVD-R/RW/ROM discs. Keeping the same terminology as DVD video, individual DivX video files are called "Titles". When naming files/titles on a CD-R/RW or a DVD-R/RW disc prior to burning, keep in mind that by default they will be played in alphabetical order.

Official DivX® Certified product
Plays all versions of DivX® video (including DivX® 6) with standard playback of DivX® media files

- DivX, DivX Certified, and associated logos are trademarks of DivX, Inc. and are used under license. 

To protect the LCD screen

- Do not allow direct sunlight to fall on the display when this unit is not being used. Extended exposure to direct sunlight can result in LCD screen malfunction due to the resulting high temperatures.
- When using a cellular phone, keep the antenna of the cellular phone away from the display to prevent disruption of the video by the appearance of spots, colored stripes, etc.
- Never touch the screen with anything besides your finger when operating the touch panel function. The screen can scratch easily. 

For viewing LCD comfortably

Due to its construction, the viewing angle of the LCD screen is limited. You can adjust it by changing either screen size or picture adjustment.

Changing the wide screen size

By changing the screen size from 4:3 to 16:9, you can adjust the screen so that the screen can fit to the video image you are playing. For details concerning operation, refer to *Changing the wide screen mode* on page 50.



Changing the picture adjustment





You can make the best adjustment to the picture display by changing **BRIGHTNESS**, **CONTRAST**, **COLOR** and **HUE**. You can also dim or enlight the overall picture image using **DIMMER**.

For details concerning operation, refer to *Changing the picture adjustment* on page 51. 

What the marks on DVDs indicate

The marks below may be found on DVD disc labels and packages. They indicate the type of images and audio recorded on the disc, and the functions you can use.



Mark	Meaning
	Indicates the number of audio systems.
	Indicates the number of subtitle languages.
	Indicates the number of viewing angles.

Mark	Meaning
16 : 9 LB	Indicates the picture size (aspect ratio: screen width-to-height ratio) type.
   	Indicates the number of the region where playback is possible.

When an operation is prohibited

When you are watching a DVD and attempt to perform an operation, it may not be performed because of the programming on the disc.

When this happens, the icon  appears on the screen.

- The icon  may not appear with certain discs. .

Protecting your unit from theft

The front panel can be detached to deter theft.

- If the front panel is not detached from the head unit within four seconds of turning off the ignition, a warning tone will sound.
- You can turn off the warning tone. See *Switching the warning tone* on page 48.

Important

- Handle gently when removing or attaching the front panel.
- Avoid subjecting the front panel to excessive shocks.
- Keep the front panel out of direct sunlight and high temperatures.
- If removed, replace the front panel on the unit before starting up your vehicle.

Removing the front panel

1 Press DETACH to release the front panel.

2 Grab the front panel and remove.

Take care not to grip it too tightly or to drop the front panel and protect it from contact with water or other fluids to prevent permanent damage.

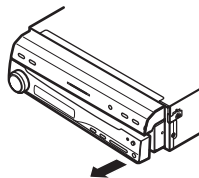

3 Put the front panel into provided protective case for safe keeping.

Attaching the front panel

- Replace the front panel by clipping it into place. .

Resetting the microprocessor

Pressing **RESET** lets you reset the microprocessor to its initial settings without changing the bookmark information.

The microprocessor must be reset under the following conditions:

- Prior to using this unit for the first time after installation
- If the unit fails to operate properly
- When strange or incorrect messages appear on the display

1 Turn the ignition switch OFF.

Before You Start

2 Press **RESET** with a pen tip or other pointed instrument.

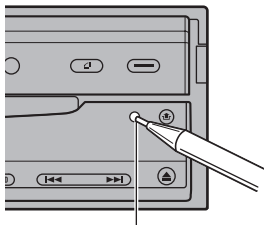

RESET button

Note

After completing connections or when you want to erase all memorized settings or return the unit to its initial (factory) settings, switch your engine ON or set the ignition switch to ACC ON before pressing **RESET**. ■

Feature demo mode

The feature demo automatically starts when you select the source **OFF**. The demo continues while the ignition switch is set to ACC or ON. To cancel the feature demo, press and hold **VOLUME/ATT**. To restart the feature demo, press and hold **VOLUME/ATT** again. Remember that if the feature demo continues operating when the car engine is turned off, it may drain battery power.

Important

The red lead (ACC) of this unit should be connected to a terminal coupled with ignition switch on/off operations. If this is not done, the vehicle battery may be drained. ■

Use and care of the remote control

Installing the battery

Slide the tray out on the back of the remote control and insert the battery with the plus (+) and minus (-) poles pointing in the proper direction.

- When using for the first time, pull out the film protruding from the tray.

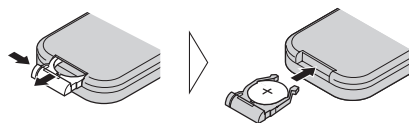

WARNING

Keep the battery out of the reach of children. Should the battery be swallowed, immediately consult a doctor.

CAUTION

- Use only one **CR2025 (3 V)** lithium battery.
- Remove the battery if the remote control is not used for a month or longer.
- Danger of explosion if battery is incorrectly replaced. Replace only with the same or equivalent type.
- Do not handle the battery with metallic tools.
- Do not store the battery with metallic materials.
- In the event of battery leakage, wipe the remote control completely clean and install a new battery.
- When disposing of used batteries, please comply with governmental regulations or environmental public institutions' rules that apply in your country/area.

Using the remote control

Point the remote control in the direction of the front panel to operate.

- The remote control may not function properly in direct sunlight.



Important

- Do not store the remote control in high temperatures or direct sunlight.
- Do not let the remote control fall onto the floor, where it may become jammed under the brake or accelerator pedal. 

Operating this unit

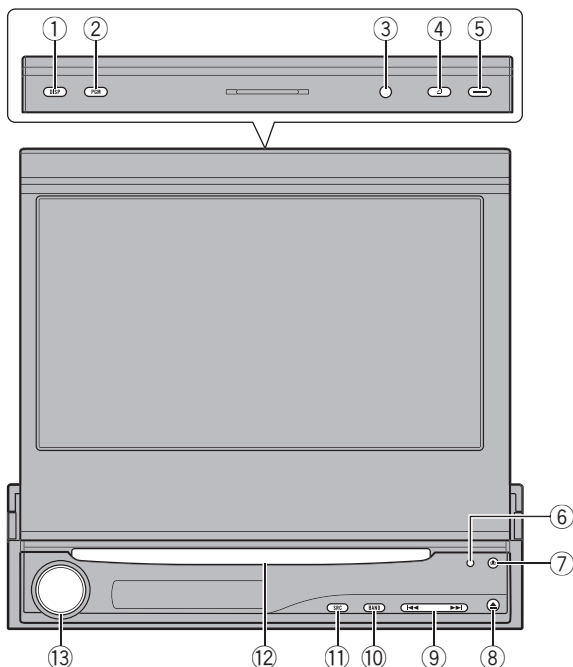

What's What Head unit

① **DISPLAY button**

Press to turn the information display on or off when the video is displayed. Press and hold to switch between the displays on the sub-display.

- When a rear view camera video is displayed, press and hold **DISPLAY** return to the source display.

② **PGM button**

Press to operate the preprogrammed functions for each source. (Refer to *Using the PGM button* on page 56.)

③ **Ambient light sensor**

Senses ambient light. This system automatically adjusts the brightness of the display to compensate for ambient light.

④ **FLIP DOWN button**

Press to turn the LCD panel horizontal temporarily from upright position.

⑤ **OPEN/CLOSE button**

Press to open or close the LCD panel.

⑥ **RESET button**

Press to return to the factory settings (initial settings).

⑦ **DETACH button**

Press to remove the front panel from the head unit.

⑧ EJECT button

Press to eject a disc from this unit.

⑨ ◀◀/▶▶ button

Press to do manual seek tuning, fast forward, reverse and track search controls.

⑩ BAND/ESC button

Press to select among three FM bands and one AM band and to cancel the control mode of functions.

⑪ SOURCE button

This unit is turned on by selecting a source. Press to cycle through all the available sources.

⑫ Disc loading slot

Insert a disc to play.

⑬ VOLUME/ATT button

Rotate it to increase or decrease the volume.

Press to quickly lower the volume level, by about 90%. Press once more to return to the original volume level.

Operating this unit

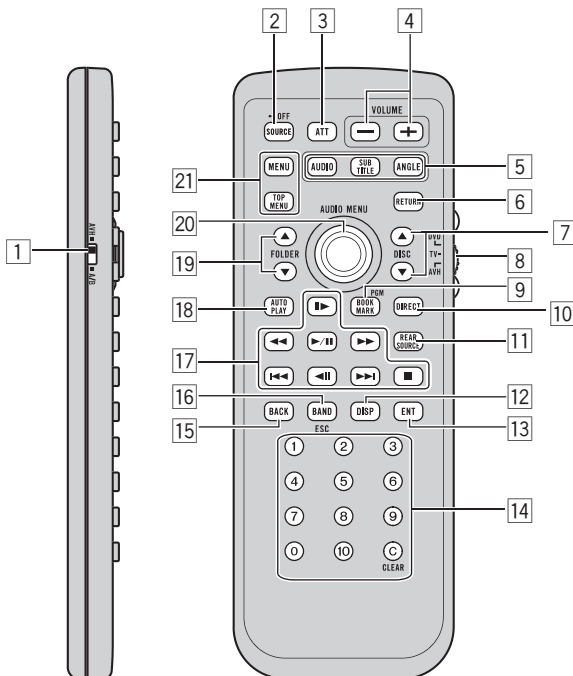

Remote control

	Button names	AVH mode	DVD mode
1	Remote control selection switch	Switch to change the setting of the remote control. For details, refer to <i>Setting remote control code type</i> on page 46.	
2	SOURCE button	Press to cycle through all the available sources. Press and hold to turn the source off.	
3	ATT button	Press to quickly lower the volume level, by about 90%. Press once more to return to the original volume level.	
4	VOLUME buttons	Press to increase or decrease the volume.	
5	AUDIO button	Press to change the audio language during DVD playback.	
	SUBTITLE button	Press to change the subtitle language during DVD playback.	
	ANGLE button	Press to change the viewing angle during DVD playback.	
6	RETURN button	Press to display the PBC (playback control) menu during PBC playback.	

Operating this unit

	Button names	AVH mode	DVD mode
7	▲/▼ buttons (DISC)	Not used.	Remote control code: AVH or B Not used. Remote control code: A Press to select the next/previous disc.
8	Remote control operation mode switch	Switch the operation mode between AVH , DVD and TV modes. Normally, set to AVH . For details, refer to <i>Using the remote control operation mode switch</i> on the next page.	
9	BOOKMARK button/ PGM button	Press to operate the preprogrammed functions for each source. (Refer to <i>Using the PGM button</i> on page 56.)	Press to turn the bookmark function on or off when your DVD player features bookmark function. For details, refer to DVD player's operation manual.
10	DIRECT button	Not used.	
11	REAR SOURCE button	Not used.	Remote control code: AVH Not used. Remote control code: A or B Press to turn the DVD player on or off.
12	DISPLAY button	Press to select different displays.	Remote control code: AVH Not used. Remote control code: A or B Press to select different displays.
13	ENTERTAINMENT button	Not used.	
14	0 to 10 buttons, CLEAR button	Press 0 to 10 to input numbers. Buttons 1 to 6 can operate the preset tuning for the tuner or disc changing for DVD player or multi-CD player. Press CLEAR to clear the input numbers.	Press to select a menu item on the Video CDs featuring PBC (playback control).
15	BACK button	Press to return to the previous display.	Not used.
16	BAND/ESC button	Press to select the tuner band when tuner is selected as a source. Also used to cancel the control mode of functions. Press to switch mode between compressed audio and audio data (CD-DA) when playing discs with compressed audio and audio data (CD-DA) such as CD-EXTRA and MIXED-MODE CDs.	Press to switch mode between compressed audio and audio data (CD-DA) when playing discs with compressed audio and audio data (CD-DA) such as CD-EXTRA and MIXED-MODE CDs.

Operating this unit

	Button names	AVH mode	DVD mode
17	PLAY/PAUSE (▶/⏸) button	Press to switch sequentially between playback and pause.	
	REVERSE (◀◀) button	Press to perform fast reverse.	
	FORWARD (▶▶) button	Press to perform fast forward.	
	PREVIOUS (◀◀) button	Press to return to the previous track (chapter).	
	NEXT (▶▶) button	Press to go to the next track (chapter).	
	STEP (⏮/▶) buttons	Press to move ahead one frame at a time during DVD/VideoCD playback. Press and hold for one second to activate slow playback.	
	STOP (■) button	Press to stop playback.	
18	AUTO PLAY button	Press to turn the DVD auto-playback function on or off.	
19	▲/▼ buttons (FOLDER)	Press to select the next/previous folder.	
20	Joystick	Move to do fast forward, reverse and track search controls. Click to recall MENU .	Move to select a menu on the DVD menu.
21	MENU button	Press to display the DVD menu during DVD playback.	
	TOP MENU button	Press to return to the top menu during DVD playback.	

Using the remote control operation mode switch

There are three remote control operation modes on the remote control.

AVH mode operation

When operating this unit by remote control, the mode is normally switched to **AVH**.

DVD mode operation

If you switch the mode to **DVD**, the joystick and **0** to **10** operations are changed for DVD player.

● When you want to operate the following functions, switch the mode to **DVD**:

- When operating the DVD menu by using the joystick. (Refer to *Operating the DVD menu* on page 27.)

- When operating the PBC menu by using **0** to **10**. (Refer to *PBC playback* on page 28.)

TV mode operation

TV operations available with a Pioneer TV tuner (e.g. GEX-P5750TV(P)) can be controlled with **AVH** mode. **TV** mode is not used with this unit.

- For details concerning operation, refer to the TV tuner's operation manuals. ■

Basic Operations

Power ON/OFF



① Source icon

Turning the unit on

- When using the touch panel keys, touch the source icon and then touch the desired source name.

The source names are displayed and selectable ones are highlighted.

- When using the button, press **SOURCE** to turn the unit on.

Turning the unit off

- When using the touch panel keys, touch the source icon and then touch **OFF**.

- When the source icon is not displayed, you can display it by touching the screen.

- When using the button, press **SOURCE** and hold until the unit turns off.

Selecting a source

You can select a source you want to listen to. To switch to the DVD player, load a disc in the unit. To switch to the iPod, connect an iPod to this unit.

- When using the touch panel keys, touch the source icon and then touch the desired source name.

The source names are displayed and selectable ones are highlighted.

- **DVD** – Built-in DVD player
 - **RADIO** – Radio
 - **iPod** – iPod
 - **USB** – USB portable audio player/USB memory
 - **TEL** – BT telephone
 - **BT Audio** – Bluetooth audio player
 - **S-DVD** – DVD player/multi-DVD player
 - **MCD** – Multi-CD player
 - **AUX 1** – AUX 1
 - **AUX 2** – AUX 2
 - **AV** – AV input
 - **TV** – Television
 - **EXT 1** – External unit 1
 - **EXT 2** – External unit 2
 - **OFF** – Turn the unit off
- When the source icon is not displayed, you can display it by touching the screen.
 - While operating the menu, you cannot select a source by touching the source icon.
 - To close source select menu, touch **ESC**.
- When using the button, press **SOURCE** repeatedly to select a desired source.



Notes

- In the following cases, the sound source will not change:
 - When there is no unit corresponding to the selected source connected to this unit.
 - When there is no disc or magazine in the player.
 - When the AUX (auxiliary input) is set to off (refer to page 47).
 - When the AV (AV input) is not set to **VIDEO** (refer to page 52).
- AUX1 is set to **VIDEO** by default. Set the AUX1 to **OFF** when not in use (refer to *Switching the auxiliary setting* on page 47).

Operating this unit

- External unit refers to a Pioneer product (such as one available in the future) that, although incompatible as a source, enables control of basic functions by this unit. Two external units can be controlled by this unit. When two external units are connected, the allocation of them to external unit 1 or external unit 2 is automatically set by this unit.
- When this unit's blue/white lead is connected to the vehicle's auto-antenna relay control terminal, the vehicle's antenna extends when this unit's source is turned on. To retract the antenna, turn the source off.

Adjusting the volume

- Use **VOLUME/ATT** to adjust the sound level.

Rotate **VOLUME/ATT** to increase or decrease the volume.

Touch panel key basic operation

Activating the touch panel keys



- TILT** (←/→) keys
Touch to adjust the LCD panel angle.
- Touch panel keys
Touch to do various operations.

1 Touch the screen to activate the touch panel keys corresponding to each source.

- The touch panel keys appear on the display.
- To go to the next group of touch panel keys, touch **NEXT**.

- To return to the previous group of touch panel keys, touch **PREV**.

2 Touch HIDE to hide the touch panel keys.



If you do not use the touch panel keys within 30 seconds, they will be hidden automatically when selecting video sources.

Operating the menu

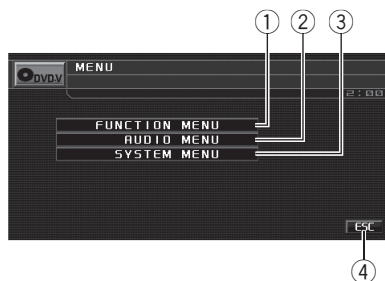

- FUNCTION MENU** key
Touch to select functions for each source.
- AUDIO MENU** key
Touch to select various sound quality controls.
- SYSTEM MENU** key
Touch to select various setup functions.
- ESC** key
Touch to cancel the control mode of functions.

1 Touch A.MENU to display MENU.

The menu names are displayed and operable ones are highlighted.

- When **A.MENU** is not displayed, you can display it by touching the screen.

2 Touch the desired key to display the function names you want to operate.

- To go to the next group of function names, touch **NEXT**.

- To return to the previous group of function names, touch **PREV.**

3 Touch ESC to return to the display of each source.

Opening and closing the LCD panel

The LCD panel will be opened or closed automatically with the turning of the ignition switch on or off. You can turn off the automatic close/open function. (Refer to page 54.)

- Do not close the LCD panel with hands by force. That cause malfunction.
- The automatic close/open function will operate the display as follows.
 - When the ignition switch is turned OFF while the LCD panel is opened, the LCD panel will close after six seconds.
 - When the ignition switch is turned ON again (or turned to ACC), the LCD panel will be opened automatically.
 - Removing or attaching the front panel will automatically close or open the LCD panel. (Refer to page 12.)
- When the ignition switch is turned OFF after the LCD panel has been closed, turning the ignition switch ON again (or turning it to ACC) will not open the LCD panel. In this case, press **OPEN/CLOSE** to open the LCD panel.
- When closing the LCD panel, check to make sure that it has closed completely. If the LCD panel has stopped halfway, leaving it like this could result in damage.

CAUTION

Keep hands and fingers clear of the unit when opening, closing, or adjusting the LCD panel. Be especially cautious of children's hands and fingers.

● Press OPEN/CLOSE to open the LCD panel.

- To close the LCD panel, press **OPEN/CLOSE** again.

Adjusting the LCD panel angle

👤 Important

- If you can hear the LCD panel knocking against your vehicle's console or dashboard, touch **TILT** (↙↘/↗↞) to move the LCD panel a little forward.
- When adjusting the LCD panel angle, be sure to touch **TILT** (↙↘/↗↞). Forcibly adjusting the LCD panel by hand may damage it.



● Touch TILT (↙↘/↗↞) to adjust the LCD panel to an easily viewable angle.

The LCD panel angle continues changing as long as you touch **TILT** (↙↘/↗↞) and hold.

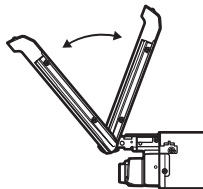

- The adjusted LCD panel angle will be memorized and automatically returned to the next time the LCD panel is opened.

Operating this unit

Turning the LCD panel horizontal

When the LCD panel is upright and it hinders the operation of the air conditioner, the panel can be turned horizontal temporarily.

- **Press FLIP DOWN to turn the LCD panel horizontal.**

- To return to original position, press

FLIP DOWN again.

- The LCD panel returns to the original position automatically with beeping sound 10 seconds after operation. 

Radio

Basic Operations

Important

If you are using this unit in North, Central or South America, reset the AM tuning step (see *Setting the AM tuning step* on page 47).

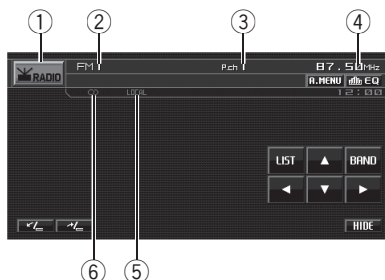

- ① Source icon
- ② Band indicator
- ③ Preset number indicator
- ④ Frequency indicator
- ⑤ **LOCAL** indicator
Shows when local seek tuning is on.
- ⑥ Stereo (◐) indicator
Shows when the selected frequency is being broadcast in stereo.

1 Touch the source icon and then touch RADIO to select the radio.

2 Touch BAND to select a band.

Touch **BAND** until the desired band (**FM1**, **FM2**, **FM3** for FM or **AM**) is displayed.

3 To perform manual tuning, briefly touch ◀ or ▶.

- You can also perform manual tuning by pressing ◀◀ or ▶▶.

4 To perform seek tuning, keep touching ◀ or ▶ for about one second and release.

The tuner will scan the frequencies until a broadcast strong enough for good reception is found.

- You can cancel seek tuning by briefly touching either ◀ or ▶.
- If you keep touching ◀ or ▶ you can skip stations. Seek tuning starts as soon as you release the key.
- You can also perform seek tuning by pressing and holding ◀◀ or ▶▶.



Note

Listening AM radio while an iPod is charged from this unit may generate noise. In this case, turn the iPod charge setting off and noise is disappeared. (Refer to *Switching the iPod charge setting* on page 54.)

Storing and recalling broadcast frequencies

You can easily store up to six broadcast frequencies for later recall.

- Up to 18 FM stations, six for each of the three FM bands, and six AM stations can be stored in memory.

1 Touch LIST to display the preset list.

2 When you find a frequency that you want to store in memory keep touching one of preset tuning keys P1 to P6 until the beep sounds.

The selected radio station frequency has been stored in memory.

The next time you touch the same preset tuning key the radio station frequency is recalled from memory.

3 Touch ESC to return to the ordinary display.



Note

You can also use ▲ and ▼ to recall radio station frequencies assigned to preset tuning keys **P1** to **P6**.

Introduction of advanced operations

1 Touch A.MENU and then touch FUNCTION MENU to display the function names.

The function names are displayed and operable ones are highlighted.

2 Touch ESC to return to the frequency display.

- To return to the previous display, touch **BACK**.

Storing the strongest broadcast frequencies

BSM (best stations memory) lets you automatically store the six strongest broadcast frequencies under preset tuning keys **P1** to **P6** and once stored there you can tune in to those frequencies with the touch of a key.

- Storing broadcast frequencies with BSM may replace broadcast frequencies you have saved using **P1** to **P6**.

● Touch BSM on the function menu to turn BSM on.

BSM begins to flash. While **BSM** is flashing the six strongest broadcast frequencies will be stored under preset tuning keys **P1** to **P6** in order of their signal strength. When finished, **BSM** stops flashing.

- To cancel the storage process, touch **BSM** again.

Operating this unit

Tuning in strong signals

Local seek tuning lets you tune in only those radio stations with sufficiently strong signals for good reception.

- **Touch LOCAL on the function menu to set the sensitivity.**

Touch **LOCAL** repeatedly until the desired level of sensitivity appears in the display.

There are four levels of sensitivity for FM and two levels for AM:

FM: **OFF—LEVEL1—LEVEL2—LEVEL3—LEVEL4**

AM: **OFF—LEVEL1—LEVEL2**

The **LEVEL4** setting allows reception of only the strongest stations, while lower settings let you receive progressively weaker stations. 

Built-in DVD player

Basic Operations

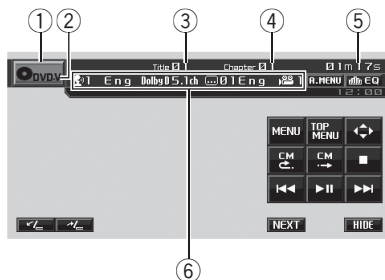

- ① Source icon
- ② Media indicator
Shows the type of disc currently playing.
- ③ Title/Folder number indicator
DVD: shows the title currently playing.
Compressed audio and DivX: shows the folder currently playing.
- ④ Chapter/track/file number indicator
DVD: shows the chapter currently playing.
Video CD and CD: shows the track currently playing.
Compressed audio and DivX: shows the file currently playing.
- ⑤ Play time indicator
- ⑥ Variable message area
DVD video: shows the subtitle language, audio language and viewing angle.
CD TEXT, compressed audio, DivX and DVD-VR: shows the text information of currently playing disc.

1 Insert a disc into the disc loading slot.

Playback will automatically start.

- **Be sure to turn up the label side of a disc.**
- After a disc has been inserted, use touch panel keys to select the DVD player.
- When the automatic playback function is on, this unit will cancel the DVD menu and automatically start playback from the first chapter of the first title. Refer to *Automatic playback of DVDs* on page 31.

- With some DVD discs, a menu may be displayed. (Refer to *Operating the DVD menu* on the next page.)
- With a Video CD featuring the PBC (playback control) function, a menu is displayed. (Refer to *PBC playback* on page 28.)
- To eject a disc, press **EJECT**.

2 Touch the screen to display the touch panel keys.

3 When playing a compressed audio or DivX, touch ▲ or ▼ to select a folder.

- To return to folder **01** (ROOT), press and hold **BAND/ESC**. However, if folder **01** (ROOT) contains no files, playback commences with folder **02**.

4 To skip back or forward to another chapter/track, briefly touch ◀◀ or ▶▶.

- You can also skip back or forward to another chapter/track by pressing ◀◀ or ▶▶.
- During PBC playback, a menu may be displayed if you perform these operations.

5 To perform fast forward or reverse, keep touching ◀◀ or ▶▶.

When DVD, DivX disc or Video CD is playing, if you keep touching ◀◀ or ▶▶ for five seconds, the icon ◀◀ or ▶▶ is highlighted.

When this happens, fast reverse/fast forward continues even if you release ◀◀ or ▶▶. To resume playback at a desired point, touch ▶◀.

- When playing DVD video or Video CD, fast forward/fast reverse may not be possible at certain locations on some discs. If this happens, normal playback automatically resumes.



Notes

- If you do not use the touch panel keys within 30 seconds, they will be hidden automatically when displaying video image.

- Read the precautions with discs and player on *Handling guideline of discs and player* on page 92.
- If an error message such as **ERROR-02-XX** is displayed, refer to *Error messages* on page 89.
- If bookmark function is on, DVD playback resumes from the selected point. For more details, refer to *Resume playback (Bookmark)* on page 29.
- If a disc contains a mixture of various media file types such as DivX and MP3, you can switch between media file types to play. Refer to *Switching the media file type* on the next page.
- There is sometimes a delay between starting up disc playback and the sound being issued. When being read, **FORMAT READ** is displayed.
- When playing back files recorded as VBR (variable bit rate) files, the play time will not be correctly displayed if fast forward or reverse operations are used.
- When playing back WMA files, album title list does not appear.
- If the characters recorded on the disc are not compatible with this unit, those characters will not be displayed.

Basic playback controls

The table below shows the basic controls for playing discs. The following chapters cover other playback features in more details.

Key	What it does
▶◀	Starts playback, pauses a disc that's playing or restarts a paused disc.
■	Stops playback.

Operating this unit

Key What it does

- ⏮ Skips to the start of the current track, chapter or file, then to previous tracks/chapters/files.
- Performs fast reverse by touching and holding ⏮.

- ⏭ Skips to the next track, chapter or file.
- Performs fast forward by touching and holding ⏭.



Notes

- You can also perform fast forward or reverse by pressing and holding ⏮ or ⏭ on the remote control.
- You may find with some DVD or Video CD discs that some playback controls do not work in certain parts of the disc. This is not a malfunction.

Switching the media file type

When playing a disc containing a mixture of various media file types such as DivX and MP3, you can switch between media file types to play.

- This unit allows playback of the following media file type recorded on CD-R/RW/ROM discs.
 - Audio data (CD-DA)
 - Compressed audio files
 - DivX video files
- In case of DVD-R/RW/ROM, this unit does not allow playback of audio data (CD-DA).

● Touch MEDIA to switch between media file types.

Touch **MEDIA** repeatedly to switch between the following media file types:

CD (audio data (CD-DA))—**WMA/MP3/AAC** (compressed audio)—**DivX** (DivX video files)

Operating the DVD menu

Some DVDs allow you to select from the disc contents using a menu.

- This function is available for DVD video.
- You can display the menu by touching **MENU** or **TOP MENU** while a disc is playing. Touching either of these keys again lets you start playback from the location selected from the menu. For details, refer to the instructions provided with the disc.

Using DVD menu direct touch control

This function allows you to operate the DVD menu by touching the menu item directly.

- **Touch the desired menu item on the DVD menu directly.**
 - Depending on the contents of DVD discs, this function may not work properly. In this case, using touch panel keys operate the DVD menu.

Using the touch panel keys

1 Touch ⏪ to display touch panel keys to operate the DVD menu.

- When the touch panel keys are not displayed, you can display them by touching the screen.
- To switch to the DVD menu direct touch control, touch **TOUCH**.

2 Touch ▲, ▼, ◀ or ▶ to select the desired menu item.

3 Touch ENTER.

Playback starts from the selected menu item.

- If you switch the remote control operation mode to **DVD**, the joystick on the remote control can also operate the DVD menu. (Refer to page 19.)
- The way to display the menu differs depending on the disc.

PBC playback

During playback of Video CDs featuring PBC (Playback Control), **PBC ON** is displayed. You can operate PBC menu with **10Key**.

- This function is available for Video CD.

1 When PBC menu is displayed, touch **SEARCH** and then touch **10Key**.

▪ Depending on the discs, the menu may be two or more pages long. In such case, touch **◀◀** or **▶▶** to display the next or previous menu.

2 Touch **0** to **9** corresponding to a menu number and then touch **ENTER** to start playback.

Playback starts from the selected menu item.

3 Touch **ESC** to hide the touch panel keys.



Notes

- You can display the menu by touching **RETURN** during PBC playback. For details, refer to the instructions provided with the disc.
- PBC playback of Video CD cannot be cancelled.
- During playback of Video CDs featuring PBC (Playback Control), **PBC ON**, search and time search functions cannot be used nor can you select the range for repeat play.

Playing DivX® VOD content

Some DivX VOD (video on demand) content may only be playable a fixed number of times. When you load a disc containing this type of DivX VOD content, the remaining number of plays is shown on-screen and you then have the option of playing the disc (thereby using up one of the remaining plays), or stopping. If you load a disc that contains expired DivX VOD content (for example, content that has zero remaining plays), **RENTAL EXPIRED** is displayed.

- If your DivX VOD content allows an unlimited number of plays, then you may load the disc into your player and play the content as often as you like, and no message will be displayed.



Important

- In order to play DivX VOD content on this unit, you first need to register the unit with your DivX VOD content provider. About your registration code, refer to *Displaying your DivX® VOD registration code* on page 45.
- DivX VOD content is protected by a DRM (Digital Rights Management) system. This restricts playback of content to specific, registered devices.

● If the message is displayed after loading a disc containing DivX VOD content, touch **PLAY**.

Playback of the DivX VOD content will start.

- To skip to the next file, touch **NEXT PLAY**.
- If you do not want to play the DivX VOD content, touch **STOP**.

Skipping back or forward to another title

- This function is available for DVD.

● To skip back or forward to another title, touch **▲** or **▼**.

Touching **▲** skips to the start of the next title. Touching **▼** skips to the start of the previous title.

Title numbers are displayed for eight seconds.

- To switch between groups of touch panel keys, touch **NEXT** or **PREV**.

Selecting the play mode

You have two methods for playing DVD-VR disc; **ORIGINAL** (original) and **PLAYLIST** (playlist).

Operating this unit



- Titles created with DVD recorders are called original. Based on original, rearranged titles are called playlist. Playlists are created on DVD-R/RW discs.
- This function is available for DVD-VR.



● Touch **MODE CHANGE** to switch the play mode.

If the play mode is changed, playback starts from the beginning of the selected play mode.

CM skip/CM back

This function skips a reproduced image for a specified time. If the currently playing disc contains commercials, it is possible to skip them.

- This function is available for DVD.
- **To skip progressively backward or forward, touch  or .**

Each time you touch  or  it changes steps in the following order:

CM back

5 sec.—15 sec.—30 sec.—1.0 min.—2.0 min.—3.0 min.

CM skip

30 sec.—1.0 min.—1.5 min.—2.0 min.—3.0 min.—5.0 min.—10.0 min.

Resume playback (Bookmark)

The Bookmark function lets you resume playback from a selected scene the next time the disc is loaded.

- This function is available for DVD video.
- **During playback, touch **BOOKMARK** at the point you want to resume playback next time.**

The selected scene will be bookmarked so that playback resumes from that point next time. You can bookmark up to five discs. After that, the oldest bookmark is replaced by the new one.

- To switch between groups of touch panel keys, touch **NEXT** or **PREV**.

- To clear the bookmark on a disc, keep touching **BOOKMARK** during playback.

- If you switch the remote control operation mode to **DVD**, you can also bookmark a disc using **BOOKMARK** on the remote control. (Refer to page 19.)

- You can also bookmark a disc by pressing and holding **EJECT** at the point you want to bookmark. Next time you load the disc, playback will resume from the bookmarked point. Note that you can only bookmark one disc using this method. To clear the bookmark on a disc, press **EJECT**.

Searching for the part you want to play

You can use the search function to find the part you want to play.

- This function is available for DVD, DivX disc and Video CD.
- Chapter search, track search and time search are not possible when disc playback has been stopped.
- During playback of Video CDs featuring PBC (playback control), this function cannot be operated.

1 Touch **SEARCH**.

- To switch between groups of touch panel keys, touch **NEXT** or **PREV**.

2 Touch the desired search option (e.g., **CHAP**).

- You cannot operate this step during DivX disc playback.

3 Touch **0** to **9** to input the desired number.

- To cancel the inputted numbers, touch **C**.
- In the time search function, to select 1 hour 11 minutes, convert the time into 71 minutes 00 seconds and touch **7**, **1**, **0** and **0** in that order.

4 Touch ENTER.

This starts playback from the selected part.

Note

With DVD discs featuring a menu, you can also touch **MENU** or **TOP MENU** and then make selections from the displayed menu.

Changing audio language during playback (Multi-audio)

DVDs can provide audio playback with different languages and different systems (Dolby Digital, DTS etc.). With DVDs featuring multi-audio recordings, you can switch between languages/audio systems during playback.

- This function is available for DVD and DivX disc.

● Touch **AUDIO** during playback.

Each time you touch **AUDIO** it switches between audio systems.

- To switch between groups of touch panel keys, touch **NEXT** or **PREV**.

Notes

- With some DVDs, switching between languages/audio systems may only be possible using a menu display.
- You can also switch between languages/audio systems using **DVD SETUP**. For details, refer to *Setting the audio language* on page 42.
- Only digital output of DTS audio is possible. If this unit's optical digital outputs are not connected, DTS audio will not be output, so select an audio setting other than DTS.
- Display indications such as **Dolby D** and **5.1ch** indicate the audio system recorded on the DVD. Depending on the setting, playback may not be with the same audio system as that indicated.
- Touching **AUDIO** during fast forward/fast reverse, pause or slow motion playback returns you to normal playback.

Changing the subtitle language during playback (Multi-subtitle)

With DVDs featuring multi-subtitle recordings, you can switch between subtitle languages during playback.

- This function is available for DVD and DivX disc.

● Touch **SUBTITLE** during playback.

Each time you touch **SUBTITLE** it switches between subtitle languages.

- To switch between groups of touch panel keys, touch **NEXT** or **PREV**.

Notes

- With some DVDs, switching between subtitle languages may only be possible using a menu display.
- You can also switch between subtitle languages using **DVD SETUP**. For details, refer to *Setting the subtitle language* on page 42.
- Touching **SUBTITLE** during fast forward/fast reverse, pause or slow motion playback returns you to normal playback.

Changing the viewing angle during playback (Multi-angle)

With DVDs featuring multi-angle (scenes shot from multiple angles) recordings, you can switch among viewing angles during playback.

- This function is available for DVD video.
- During playback of a scene shot from multiple angles, the angle icon  is displayed. Turn angle icon display on or off using **DVD SETUP**. For details, refer to *Setting the angle icon display* on page 43.

● Touch **ANGLE** during playback of a scene shot from multiple angles.

Each time you touch **ANGLE** it switches between angles.

Operating this unit

- To switch between groups of touch panel keys, touch **NEXT** or **PREV**.

Note

Touching **ANGLE** during fast forward/fast reverse, pause or slow motion playback returns you to normal playback.

Frame-by-frame playback

This lets you move ahead one frame at a time during playback.

- This function is available for DVD and Video CD.
- **Touch **II▶** during playback.**
Each time you touch **II▶**, you move ahead one frame.
 - To return to normal playback, touch **▶II**.
 - To switch between groups of touch panel keys, touch **NEXT** or **PREV**.
 - With some discs, images may be unclear during frame-by-frame playback.

Slow motion playback

This lets you slow down playback speed.

- This function is available for DVD and Video CD.
- **Keep touching **II▶** until **III▶** is displayed during playback.**
The icon **III▶** is displayed, forward slow motion playback begins.
 - Touching **◀II** or **II▶** during slow motion playback, you can change the playback speed in four steps as follows:
1/16—1/8—1/4—1/2
 - During DVD playback, only the remote control can perform this operation.
 - To switch between groups of touch panel keys, touch **NEXT** or **PREV**.
 - To return to normal playback, touch **▶II**.

Notes

- There is no sound during slow motion playback.
- With some discs, images may be unclear during slow motion playback.
- Reverse slow motion playback is not possible.

Return to the specified scene

You can return to the specified scene where the DVD you are currently playing has been preprogrammed to return.

- This function is available for DVD video.
- **Touch **RETURN** to return to the specified scene.**
 - To switch between groups of touch panel keys, touch **NEXT** or **PREV**.
 - If a specified scene has not been preprogrammed in DVD disc, this function is not possible.

Automatic playback of DVDs

When a DVD disc with DVD menu is inserted, this unit will cancel the DVD menu automatically and start playback from the first chapter of the first title.

- This function is available for DVD video.
- Some DVDs may not operate properly. If this function is not fully operated, turn this function off and start playback.

● **Touch **AUTO PLAY** to turn automatic playback on.**

- To turn automatic playback off, touch **AUTO PLAY** again.
 - You can also turn automatic playback on or off by pressing **AUTO PLAY** button on the remote control.
- To switch between groups of touch panel keys, touch **NEXT** or **PREV**.

- When the automatic playback is on, you cannot operate repeating play of DVD disc (refer to *Repeating play* on the next page).

Text information

Text information recorded on a disc can be displayed. Text information is displayed on variable message area.

- This function is available for CD TEXT, compressed audio disc, DivX disc and DVD-VR.

Displaying text information

● Touch INFO.

Touch **INFO** repeatedly to switch between the following settings:

For CD TEXT discs

🎵: disc title—👤: disc artist name—🎵: track title—🎵: track artist name

For compressed audio discs

📁: folder name—📄: file name—🎵: album title—🎵: track title—👤: artist name

For DivX discs

📁: folder name—📄: file name

For DVD-VR discs

ORIGINAL/**PLAYLIST**: playback mode—🎵: title name

Notes

- Some discs have certain information encoded on the disc during manufacture. These discs may contain such information as the CD title, track title, artist's name and playback time and are called CD TEXT discs.
- If specific information has not been recorded on a CD TEXT disc, **No XXXX** will be displayed (e.g., **No Name**).
- If specific information has not been recorded on a compressed audio disc, **no xxxx** will be displayed (e.g., **no artist**).
- When playing back WMA files, album title is not displayed.

Selecting tracks from the track list

Track list lets you see the list of tracks on a disc and select one of them to play back. When playing a CD TEXT disc, track titles are displayed.

- This function is available for CD.

1 Touch LIST.

2 Touch or to switch between the lists of tracks.

3 Touch your favorite track.

That selection will begin to play.

4 Touch ESC to return to the ordinary display.

Operating this unit

Selecting files from the file name list

File name list lets you see the list of file names (or folder names) and select one of them to playback.

- This function is available for compressed audio disc and DivX disc.

1 Touch LIST.

2 Touch or to switch between the lists of titles.

3 Touch your favorite file name (or folder name).

That selection will begin to play.

- When you have selected a folder, a list of the names of the files (or the folders) in it can be viewed. Repeat steps 2 and 3 to select the desired file name.
- To return to the previous list (the folder one level higher), touch .

4 Touch ESC to return to the ordinary display.

Selecting titles from the title list

Title list lets you see the list of titles on a disc and select one of them to play back.

- This function is available for DVD-VR.

1 Touch LIST.

2 Touch or to switch between the lists of titles.

3 Touch your favorite title.

That selection will begin to play.

4 Touch ESC to return to the ordinary display.

Introduction of advanced operations

1 Touch A.MENU and then touch FUNCTION MENU to display the function names.

The function names are displayed and operable ones are highlighted.

2 Touch ESC to return to the playback display.

- To return to the previous display, touch **BACK**.

Repeating play

Repeat play plays the same play range repeatedly. Play range varies depending on the media.

For DVD, play range can be selected from **DISC** (disc repeat), **TITLE** (title repeat) and **CHAPTER** (chapter repeat).

For Video CD and CD, play range can be selected from **DISC** (disc repeat) and **TRACK** (track repeat).

For compressed audio and DivX, play range can be selected from **DISC** (disc repeat), **FOLDER** (folder repeat) and **FILE** (file repeat).

- During playback of Video CDs featuring PBC (playback control), this function cannot be operated.

● Touch REPEAT on the function menu to select the repeat range.

- **TITLE** – Repeat just the current title
- **CHAPTER** – Repeat just the current chapter
- **TRACK** – Repeat just the current track
- **FILE** – Repeat just the current file
- **FOLDER** – Repeat the current folder
- **DISC** – Play through the current disc



Notes

- If you perform chapter search or fast forward/reverse, the repeat play range changes to **DISC**.

- If you select another folder during repeat play, the repeat play range changes to **DISC**.
- When playing back compressed audio or DivX, if you perform track search or fast forward/reverse during **FILE**, the repeat play range changes to **FOLDER**.
- When playing back Video CD or CD, if you perform track search or fast forward/reverse during **TRACK**, the repeat play range changes to **DISC**.
- When **FOLDER** is selected, it is not possible to play back a subfolder of that folder.
- When playing discs with compressed audio and audio data (CD-DA), repeat play performs within the currently playing data type even if **DISC** is selected.

Playing tracks in random order

Random play plays tracks in a random order within the selected repeat range.

- This function is available for CD and compressed audio disc.

1 Select the repeat range.

Refer to *Repeating play* on the previous page.

2 Touch **RANDOM** on the function menu to turn random play on.

Tracks will play in a random order within the previously selected repeat range.

- To turn random play off, touch **RANDOM** again.

Scanning tracks or folders

Scan play lets you hear the first 10 seconds of each track on the CD.

When playing the compressed audio disc, the first 10 seconds of each track of the current folder (or the first track of each folder) is played.

- This function is available for CD and compressed audio disc.

1 Select the repeat range.

Refer to *Repeating play* on the previous page.

2 Touch **SCAN** on the function menu to turn scan play on.

The first 10 seconds of each track is played.

3 When you find the desired track (or folder) touch **SCAN** again.



Note

After track or folder scanning is finished, normal playback of the tracks will begin again.

Selecting audio output

When playing DVD video discs recorded with LPCM audio, you can switch the audio output. When playing Video CD discs, you can switch between stereo and monaural audio output.

- This function is available for DVD and Video CD.
- This function is not possible when disc playback has been stopped.
- If you select **Linear PCM**, when playing a disc recorded on a dual mono mode, you can operate this function. (Refer to *Setting for digital output* on page 45.)

● Touch **L/R SELECT** on the function menu to select the audio output.

Touch **L/R SELECT** repeatedly until the desired audio output appears in the display.

- **L+R** – left and right
- **LEFT** – left
- **RIGHT** – right
- **MIX** – mixing left and right



Note

Depending on the disc and the playback location on the disc, the function may not be selectable, indicating that operating this function is not possible.

Operating this unit

Using compression

Using the COMP (compression) function lets you adjust the sound playback quality of this unit.

- Touch **COMPRESSION** on the function menu to select your favorite setting.
OFF—COMP1—COMP2

Playing songs on iPod

Basic Operations

You can use this unit to control an iPod by using a cable (e.g., CD-I200), which is sold separately.

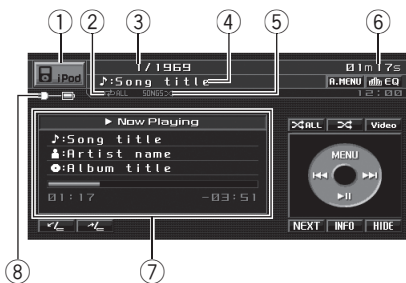

- ① Source icon
- ② Repeat indicator
Shows when repeat range is set to **ONE** or **ALL**.
- ③ Song number indicator
- ④ Song title indicator
- ⑤ Shuffle indicator
Shows when random play is set to **SONGS** or **ALBUMS**.
- ⑥ Play time indicator
- ⑦ Song information
Shows detailed information of currently playing song.
- ⑧ Battery charging indicator
Shows when the battery charge setting is on.

1 Connect the iPod to this unit.

Playback will automatically start.

While the iPod is connected to this unit, **PIONEER** (or ✓ (check mark)) is displayed on the iPod.

- Before connecting the dock connector of this unit to the iPod, disconnect the headphones from the iPod.
- After the iPod has been connected to this unit, use touch panel keys to select the iPod.

Operating this unit

- When removing the iPod from this unit, this unit is turned off.

2 To skip back or forward to another song, touch ◀◀ or ▶▶.

- You can also skip back or forward to another song by pressing ◀◀ or ▶▶.

3 To perform fast forward or reverse, keep touching ◀◀ or ▶▶.

- You can also perform fast reverse/fast forward by pressing and holding ◀◀ or ▶▶.

4 When playing Audiobook or Podcast (with chapter) on iPod, touch CHAP▲ or CHAP▼ to select a chapter.

- To switch between groups of touch panel keys, touch **NEXT** or **PREV**.



Notes

- Read the precautions with iPod on page 95.
- If an error message such as **ERROR-11** is displayed, refer to *Error messages* on page 89.
- Connect directly the dock connector of this unit to the iPod so that this unit works properly.
- When the ignition switch is set to ACC or ON, the iPod's battery is charged while the iPod is connected to this unit.
- While the iPod is connected to this unit, the iPod itself cannot be turned on or off.
- The iPod connected to this unit is turned off about two minutes after the ignition switch is set to OFF.

Browsing for a song

The operation of this unit to control an iPod is designed to be as close to the operation of the iPod as possible for easy operation and song search.

- If the characters recorded on the iPod are not compatible with this unit, those characters will not be displayed.

1 Touch **MENU** to display iPod menus.

2 Touch one of the categories in which you want to search for a song.

- **PLAYLISTS** (playlists)
- **ARTISTS** (artists)
- **ALBUMS** (albums)
- **SONGS** (songs)
- **PODCASTS** (podcasts)
- **GENRES** (genres)
- **AUDIOBOOKS** (audiobooks)

- To switch between groups of categories, touch **PREV** or **NEXT**.

3 Touch a list title that you want to play.

Repeat this operation until you find the desired song.

- You can start playback throughout the selected list by touching and holding desired list title.
- You can start a playback of all the songs in the selected list (**GENRES**, **ARTISTS** or **ALBUMS**). To do this, touch **ALL**.
- To switch between the lists of titles, touch ▲ or ▼.
- To return to the previous menu, touch **MENU**.

4 Touch **ESC** to return to the ordinary display.

Displaying text information on iPod

● Touch **INFO** to select the desired text information.

- song title—: artist name—: album title
- If the characters recorded on the iPod are not compatible with this unit, those characters will not be displayed.

Operating this unit



Repeating play

For playback of the songs on the iPod, there are two repeat play ranges: **ONE** (repeat one song) and **ALL** (repeat all songs in the list).

- While repeat play range is set to **ONE**, you cannot select the other songs.
- **Touch**  **to select the repeat range.**
 - **ONE** – Repeat just the current song
 - **ALL** – Repeat all songs in the selected list
- To switch between groups of touch panel keys, touch **NEXT** or **PREV.**

Playing songs in a random order (shuffle)

For playback of the songs on the iPod, there are two random play methods: **SONGS** (play back songs in a random order) and **ALBUMS** (play back albums in a random order).



- **Touch**  **to select the random play method.**
 - **SONGS** – Play back songs in a random order within the selected list
 - **ALBUMS** – Select an album randomly, and then play back all the songs in it in order
- To cancel the random play, touch  repeatedly until the shuffle icon is turned off.

Playing all songs in a random order (shuffle all)

This method plays all songs on the iPod randomly.

- **Touch**  **to turn shuffle all on.**
All songs on the iPod will play randomly.

Pausing a song



- **Touch**  **during playback.**
 - To resume playback at the same point that you turned pause on, touch  again.

Changing audiobook speed

While listening to an audiobook on iPod, playback speed can be changed.

- **Touch** **A.Book** **to select your favorite setting.**
 - **FASTER** – Playback faster than normal speed
 - **NORMAL** – Playback in normal speed
 - **SLOWER** – Playback slower than normal speed
- To switch between groups of touch panel keys, touch **NEXT** or **PREV.**

Playing video

This unit can play video if an iPod with video capabilities is connected. However, only the following touch panel keys can be used for iPod operation: ,  and . Use the iPod to operate other functions.

- Change the video setting on the iPod so that the iPod can output the video to an external device, before you display the video screen.
- For details, refer to the iPod's manuals.

1 Touch Video.

- To return to the music operation screen, touch **Music**.

2 Play video on the iPod by operating the iPod.

Audio Adjustments

Introduction of audio adjustments

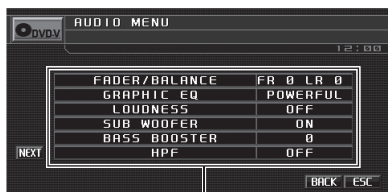

- ① Audio display
Shows the audio adjustment status.

Important

If the multi-channel processor (DEQ-P7650) is connected to this unit, the audio function will be changed to the multi-channel processor's audio menu. For details, refer to *Introduction of DSP adjustments* on page 75.

1 Touch A.MENU and then touch AUDIO MENU to display the audio function names.

The audio function names are displayed and operable ones are highlighted.

- To go to the next group of function names, touch **NEXT**.
- To return to the previous group of function names, touch **PREV**.
- When selecting the FM as the source, you cannot switch to **SLA**.

2 Touch ESC to return to the ordinary display.

- To return to the previous display, touch **BACK**.

Using balance adjustment

You can change the fader/balance setting so that it can provide you an ideal listening environment in all occupied seats.

1 Touch FADER/BALANCE on the audio function menu.

- When the rear output setting is **S.W**, **BALANCE** will be displayed instead of **FADER/BALANCE**. Refer to *Setting the rear output and subwoofer controller* on page 48.

2 Touch ▲ or ▼ to adjust front/rear speaker balance.

Each time you touch ▲ or ▼ it moves the front/rear speaker balance towards the front or the rear.

FRONT:15 to **REAR:15** is displayed as the front/rear speaker balance moves from front to rear.

- **FR: 0** is the proper setting when only two speakers are used.
- When the rear output setting is **S.W**, you cannot adjust front/rear speaker balance. Refer to *Setting the rear output and subwoofer controller* on page 48.

3 Touch ◀ or ▶ to adjust left/right speaker balance.

Each time you touch ◀ or ▶ it moves the left/right speaker balance towards the left or the right.

LEFT:15 to **RIGHT:15** is displayed as the left/right speaker balance moves from left to right.

Using the equalizer

The equalizer lets you adjust the equalization to match car interior acoustic characteristics as desired.

Recalling equalizer curves

There are seven stored equalizer curves which you can easily recall at any time. Here is a list of the equalizer curves:

Operating this unit

Display	Equalizer curve
POWERFUL	Powerful
NATURAL	Natural
VOCAL	Vocal
CUSTOM1	Custom 1
CUSTOM2	Custom 2
FLAT	Flat
SUPER BASS	Super bass

- **CUSTOM1** and **CUSTOM2** are adjusted equalizer curves that you create. Adjustments can be made with a 7-band graphic equalizer.
- When **FLAT** is selected no supplement or correction is made to the sound. This is useful to check the effect of the equalizer curves by switching alternatively between **FLAT** and a set equalizer curve.

● On the normal display, touch EQ to select the equalizer.

Touch **EQ** repeatedly to switch between the following equalizers:

**POWERFUL—NATURAL—VOCAL—
CUSTOM1—CUSTOM2—FLAT—
SUPER BASS**

Adjusting equalizer curves

The factory supplied equalizer curves, with the exception of **FLAT**, can be adjusted to a fine degree (nuance control).

1 Touch GRAPHIC EQ on the audio function menu.

2 Touch ◀ or ▶ to select an equalizer curve.

**POWERFUL—NATURAL—VOCAL—
CUSTOM1—CUSTOM2—FLAT—
SUPER BASS**

3 Touch ◀ or ▶ to adjust the equalizer curve.

+6 to -4 (or -6) is displayed as the equalizer curve is increased or decreased.

- The actual range of the adjustments are different depending on which equalizer curve is selected.
- The equalizer curve with all frequencies set to **0** cannot be adjusted.

Adjusting 7-band graphic equalizer

For **CUSTOM1** and **CUSTOM2** equalizer curves, you can adjust the level of each band.

- A separate **CUSTOM1** curve can be created for each source. If you make adjustments when a curve other than **CUSTOM2** is selected, the equalizer curve settings will be memorized in **CUSTOM1**.
- A **CUSTOM2** curve can be created common to all sources. If you make adjustments when the **CUSTOM2** curve is selected, the **CUSTOM2** curve will be updated.

1 Touch GRAPHIC EQ on the audio function menu.

2 Touch ◀ or ▶ to select an equalizer curve.

**POWERFUL—NATURAL—VOCAL—
CUSTOM1—CUSTOM2—FLAT—
SUPER BASS**

3 Touch ◀ or ▶ to select the equalizer band to adjust.

**50Hz—125Hz—315Hz—800Hz—2kHz—
5kHz—12.5kHz**

4 Touch ▲ or ▼ to adjust the level of the equalizer band.

+12dB to -12dB is displayed as the level is increased or decreased.

- You can then select another band and adjust the level.

Adjusting loudness

Loudness compensates for deficiencies in the low- and high-sound ranges at low volume.

1 Touch LOUDNESS on the audio function menu.

2 Touch ► to turn loudness on.

- To turn loudness off, touch ◀.

3 Touch ◀ or ► to select a desired level.

LOW (low)—**MID** (mid)—**HIGH** (high)

Using subwoofer output

This unit is equipped with a subwoofer output which can be turned on or off.

- When the subwoofer output is on, you can adjust the cut-off frequency and the output level of the subwoofer.

1 Touch SUB WOOFER on the audio function menu.

2 Touch ► next to SUB WOOFER to turn subwoofer output on.

- To turn subwoofer output off, touch ◀.

3 Touch ◀ or ► next to PHASE to select the phase of subwoofer output.

Touch ► to select normal phase and

NORMAL appears in the display. Touch ◀ to select reverse phase and **REVERSE** appears in the display.

4 Touch ◀ or ► next to FREQUENCY to select cut-off frequency.

Each time you touch ◀ or ► selects cut-off frequencies in the following order:

50Hz—63Hz—80Hz—100Hz—125Hz

Only frequencies lower than those in the selected range are outputted from the subwoofer.

5 Touch ◀ or ► next to LEVEL to adjust the output level of the subwoofer.

+6 to -24 is displayed as the level is increased or decreased.

Boosting the bass

Bass boost function boosts the bass level of sound lower than 100 Hz. The more the bass level is increased, the more the bass sound is emphasized and the entire sound becomes powerful. When using this function with the subwoofer, the sound under the cut-off frequency is boosted.

1 Touch BASS BOOSTER on the audio function menu.

2 Touch ◀ or ► to select a desired level.

0 to +6 is displayed as the level is increased or decreased.

Using the high pass filter

When you do not want low sounds from the subwoofer output frequency range to play from the front or rear speakers, turn on the HPF (high pass filter). Only frequencies higher than those in the selected range are outputted from the front or rear speakers.

1 Touch HPF on the audio function menu.

2 Touch ► next to HPF to turn high pass filter on.

- To turn high pass filter off, touch ◀.

3 Touch ◀ or ► next to FREQUENCY to select cut-off frequency.

Each time you touch ◀ or ► selects cut-off frequencies in the following order:

50Hz—63Hz—80Hz—100Hz—125Hz

Operating this unit

Only frequencies higher than those in the selected range are outputted from the front or rear speakers.

Adjusting source levels

SLA (source level adjustment) lets you adjust the volume level of each source to prevent radical changes in volume when switching between sources.

- Settings are based on the FM volume level, which remains unchanged.

1 Compare the FM volume level with the level of the source you wish to adjust.

2 Touch NEXT on the audio function menu.

3 Touch SLA.

4 Touch ◀ or ▶ to adjust the source volume.

Each time you touch ◀ or ▶ it increases or decreases the source volume.

+4 to -4 is displayed as the source volume is increased or decreased.



Notes

- The AM volume level can also be adjusted with source level adjustments.
- Video CD, CD, compressed audio and DivX are set to the same source level adjustment volume automatically.
- External unit 1 and external unit 2 are set to the same source level adjustment volume automatically.

Staging for car environment

You can create in car a sound environment that can be best matched with the type of your listening music (or movie).

1 Touch NEXT on the audio function menu.

2 Touch STAGING.

3 Touch ◀ or ▶ next to STAGING to select the desired staging field.

OFF (off)—**STUDIO** (studio)—**THEATER** (theater)—**STAGE** (stage)—**LIVING** (living)

4 Touch ◀ or ▶ next to POSITION to select a listening position.

LEFT (left)—**CENTER** (center)—**RIGHT** (right) 

Setting up the DVD player

Introduction of DVD setup adjustments

You can use this menu to change audio, subtitle, parental lock and other DVD settings.

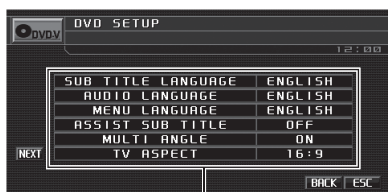

- ① DVD setup menu display
Shows the DVD setup menu names.

1 Touch ■.
SETUP will be displayed instead of **MENU**.

2 Touch SETUP.
The DVD setup function names are displayed.

- To go to the next group of function names, touch **NEXT**.
- To return to the previous group of function names, touch **PREV**.

3 Touch ESC to return to the playback display.

- To return to the previous display, touch **BACK**.

Setting the subtitle language

You can set a desired subtitle language. If the selected subtitle language is recorded on the DVD, subtitles are displayed in that language.

1 Touch SUB TITLE LANGUAGE on the DVD setup menu.
A subtitle language menu is displayed.

2 Touch the desired language.

A subtitle language is set.

- To switch to the second language select menu, touch **NEXT**.
- To return to the first language select menu, touch **PREV**.
- If you have selected **OTHERS**, refer to *When you select OTHERS* on this page.



Notes

- If the selected language is not recorded on the disc, the language specified on the disc is displayed.
- You can also switch the subtitle language by touching **SUBTITLE** during playback. (Refer to *Changing the subtitle language during playback (Multi-subtitle)* on page 30.)
- Even if you use **SUBTITLE** during playback to switch the subtitle language, this does not affect the settings here.

When you select OTHERS

When you select **OTHERS**, a language code input display is shown. Refer to *Language code chart for DVD* on page 97 to input the four-digit code of the desired language.

1 Touch 0 to 9 to input the language code.

- To cancel the inputted numbers, touch **C**.

2 Touch ENTER.

Setting the audio language

You can set the preferred audio language.

1 Touch AUDIO LANGUAGE on the DVD setup menu.

An audio language menu is displayed.

2 Touch the desired language.

The audio language is set.

Operating this unit

- To switch to the second language select menu, touch **NEXT**.
- To return to the first language select menu, touch **PREV**.
- If you have selected **OTHERS**, refer to *When you select OTHERS* on the previous page.



Notes

- If the selected language is not recorded on the disc, the language specified on the disc is outputted.
- You can also switch the audio language by touching **AUDIO** during playback. (Refer to *Changing audio language during playback (Multi-audio)* on page 30.)
- Even if you use **AUDIO** during playback to switch the audio language, this does not affect the settings here.

Setting the menu language

You can set the preferred language for displays of menus recorded on a disc.

1 Touch MENU LANGUAGE on the DVD setup menu.

A menu language menu is displayed.

2 Touch the desired language.

The menu language is set.

- To switch to the second language select menu, touch **NEXT**.
- To return to the first language select menu, touch **PREV**.
- If you have selected **OTHERS**, refer to *When you select OTHERS* on the previous page.



Note

If the selected language is not recorded on the disc, the language specified on the disc is displayed.

Switching the assist subtitle on or off

If assist subtitles are recorded on a DVD disc, you can display them by turning the assist subtitle function on.

You can turn assist subtitles on or off as desired.

● Touch ASSIST SUB TITLE on the DVD setup menu to turn assist subtitles on.

- To turn the assist subtitle off, touch **ASSIST SUB TITLE** again.

Setting the angle icon display

You can set it up so that the angle icon appears on scenes where the angle can be switched.

● Touch MULTI ANGLE on the DVD setup menu to turn angle icon display on.

- To turn the angle icon display off, touch **MULTI ANGLE** again.

Setting the aspect ratio

There are two kinds of display. A wide screen display has a width-to-height ratio (TV aspect) of 16:9, while a regular display has a TV aspect of 4:3. Be sure to select the correct TV aspect for the display connected to **REAR MONITOR OUTPUT**.

- When using a regular display, select either **LETTER BOX** or **PAN SCAN**. Selecting **16:9** may result in an unnatural picture.
- If you select the TV aspect, the unit's display changes to the same setting.

● Touch TV ASPECT on the DVD setup menu to select the TV aspect.

Touch **TV ASPECT** repeatedly until the desired TV aspect appears in the display.

Operating this unit

- **16 : 9** – Wide screen picture (16:9) is displayed as it is (initial setting)
- **LETTER BOX** – The picture is the shape of a letterbox with black bands at the top and bottom of the screen
- **PAN SCAN** – The picture is cut short at the right and left of the screen



Notes

- When playing discs that do not specify **PAN SCAN**, playback is with **LETTER BOX** even if you select **PAN SCAN** setting. Confirm whether the disc package bears the  mark. (See page 11.)
- Some discs do not enable changing of the TV aspect. For details, refer to the disc's instructions.

Setting the parental lock

Some DVD video discs let you use parental lock to restrict children from viewing violent and adult-oriented scenes. You can set the parental lock to your desired level.

- When you set a parental lock level and then play a disc featuring parental lock, code number input indications may be displayed. In this case, playback will begin when the correct code number is input.

Setting the code number and level

You need to have registered a code number for playing back discs with parental lock.

- 1 Touch **NEXT** on the DVD setup menu.
- 2 Touch **PARENTAL**.
- 3 Touch **0 to 9** to input a four digit code number.
 - To cancel the inputted numbers, touch **C**.

4 Touch **ENTER**.

The code number is set, and you can now set the level.

5 Touch any of **1 to 8** to select the desired level.

The parental lock level is set.

- **LEVEL 8** – Playback of the entire disc is possible (initial setting)
- **LEVEL 7 to LEVEL 2** – Playback of discs for children and non-adult-oriented discs is possible
- **LEVEL 1** – Playback of discs for children only is possible



Notes

- We recommend to keep a record of your code number in case you forget it.
- The parental lock level is recorded on the disc. Look for the level indication written at the disc package, included literature or on the disc itself. Parental lock of this unit is not possible if a parental lock level is not recorded in the disc.
- With some discs, the parental lock may be active only on the scenes with certain levels. The playback of those scenes will be skipped. For details, refer to the instruction manual that came with the discs.

Changing the level

You can change the set parental lock level.

- 1 Touch **NEXT** on the DVD setup menu.
- 2 Touch **PARENTAL**.
- 3 Touch **0 to 9** to input the registered code number.
- 4 Touch **ENTER**.
This enters the code number, and you can now change the level.

Operating this unit

- If you input an incorrect code number, the icon  is displayed. Touch **C** and input the correct code number.
- If you forget your code number, refer to *If you forget your code number* on this page.

5 Touch any of 1 to 8 to select the desired level.

The new parental lock level is set.

If you forget your code number

Refer to *Changing the level* on the previous page, and touch **C** 10 times. The registered code number is canceled, letting you register a new one.

Setting the DivX subtitle file

You can select whether to display DivX external subtitles or not.

- The DivX subtitles will be displayed even when **CUSTOM** is selected if no DivX external subtitle files exist.

1 Touch NEXT on the DVD setup menu.

2 Touch DivX SUB TITLE to select the desired subtitle setting.

- **ORIGINAL** – Display the DivX subtitles
- **CUSTOM** – Display the DivX external subtitles

Notes

- Up to 42 characters can be displayed on one line. If more than 42 characters are set, the line breaks and the characters are displayed on the next line.
- Up to 126 characters can be displayed on one screen. If more than 126 characters are set, the excess characters will not be displayed.

Displaying your DivX® VOD registration code

In order to play DivX VOD (video on demand) content on this unit, you first need to register the unit with your DivX VOD content provider. You do this by generating a DivX VOD registration code, which you submit to your provider.

1 Touch NEXT on the DVD setup menu.

2 Touch DivX VOD.

Your 8-digit registration code is displayed.

- Make a note of the code as you will need it when you register with a DivX VOD provider.

Setting for digital output

Audio which is outputted from digital output of this unit can be selected. Normally, set to **STREAM**. If this unit's digital output is not used, there is no need to change settings.

- Selecting **Linear PCM** enables you to switch the output channel if playing the following type of discs. (Refer to *Selecting audio output* on page 34.)
 - Dual mono mode DVD video discs
 - Bilingual DVD-VR discs

1 Touch NEXT on the DVD setup menu.

2 Touch DIGITAL OUTPUT to select the desired digital output setting.

- **STREAM** – The Dolby Digital/DTS signal is output as it is (initial setting)
- **Linear PCM** – The Dolby Digital/DTS signal is converted to and output as a linear PCM signal

Setting remote control code type

When the remote control operation switch is set to **DVD**, changing the remote control code type enables you to operate the Pioneer DVD player with the supplied remote control. There are three remote codes, code type **A**, code type **B** and code type **AVH**. When operating a multi-DVD player (e.g. XDV-P650/XDV-P6), select code **A**. When operating this unit, select code **AVH**.

1 Set the remote control selection switch on the left side of the remote control to the appropriate position with a pen tip or other pointed instrument .

- If you select **AVH** mode, there is no need to take the following procedure.
- If you select **A/B** mode, take the following procedure and change the code type to the appropriate type.

2 Press 0 and CLEAR on the remote control simultaneously to change the code type.

Initially, the code type is set to **A**. Each time you press **0** and **CLEAR** simultaneously on the remote control the code type switches between **A** and **B**. 

Initial Settings

Adjusting initial settings

Using the initial settings, you can customize various system settings to achieve optimal performance from this unit.

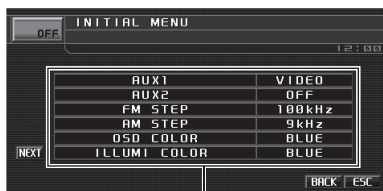

①

- ① Function display
Shows the function names.

1 Touch the source icon and then touch OFF to turn this unit off.

2 Touch the screen to display the touch panel keys.

3 Touch A.MENU and then touch INITIAL MENU to display the function names.

The function names are displayed and operable ones are highlighted.

- To go to the next group of function names, touch **NEXT**.
- To return to the previous group of function names, touch **PREV**.

4 Touch ESC to return to the ordinary display.

- To return to the previous display, touch **BACK**.

Operating this unit

Switching the auxiliary setting

Auxiliary equipments connected to this unit can be activated individually. Set each AUX source to ON when using. About connecting or using auxiliary equipments, refer to *Using the AUX source* on page 55.

Switching the auxiliary 1 setting

- **Touch AUX1 on the initial menu to select desired setting.**
 - **VIDEO** – an iPod with video capabilities connected with 4-pole mini plug cable (e.g., CD-V150M)
 - **AUDIO** – auxiliary equipment connected with stereo mini plug cable
 - **OFF** – No auxiliary equipment is connected

Switching the auxiliary 2 setting

- **Touch AUX2 on the initial menu to turn auxiliary 2 setting on.**
 - To turn auxiliary 2 setting off, touch **AUX2** again.

Setting the FM tuning step

The FM tuning step employed by seek tuning can be switched between 100 kHz, the preset step, and 50 kHz.

- **Touch FM STEP on the initial menu to select the FM tuning step.** Touching **FM STEP** will switch the FM tuning step between 50 kHz and 100 kHz. The selected FM tuning step will appear in the display.

Note

If seek tuning is performed in 50 kHz steps, stations may be tuned in imprecisely. Tune in the stations with manual tuning or use seek tuning again.

Setting the AM tuning step

The AM tuning step can be switched between 9 kHz, the preset step, and 10 kHz. When using the tuner in North, Central or South America, reset the tuning step from 9 kHz (531 kHz to 1 602 kHz allowable) to 10 kHz (530 kHz to 1 640 kHz allowable).

- **Touch AM STEP on the initial menu to select the AM tuning step.** Touching **AM STEP** will switch the AM tuning step between 9 kHz and 10 kHz. The selected AM tuning step will appear in the display.

Selecting the OSD color

You can change the OSD color.

- **Touch OSD COLOR on the initial menu to select the desired color.** Each time you touch **OSD COLOR** it selects colors in the following order: **BLUE** (blue)—**RED** (red)—**AMBER** (amber)—**GREEN** (green)—**VIOLET** (violet)

Selecting the illumination color

This unit is equipped with two illumination colors, blue and red. You can select the desired illumination color.

- **Touch ILLUMI COLOR on the initial menu to select the desired color.**

Setting the rear output and subwoofer controller

This unit's rear output (rear speaker leads output and RCA rear output) can be used for full-range speaker (**FULL**) or subwoofer (**S.W**) connection. If you switch the rear output setting to **S.W**, you can connect a rear speaker lead directly to a subwoofer without using an auxiliary amp.

- When the multi-channel processor (e.g., DEQ-P7650) is connected to this unit, you cannot operate this function.

1 Touch NEXT on the initial menu.

2 Touch REAR SP.

3 Touch ◀ or ▶ to switch the rear output setting.

Touch ◀ to select full-range speaker and **FULL** appears in the display. Touch ▶ to select subwoofer and **S.W** appears in the display.

- When no subwoofer is connected to the rear output, select **FULL**.
- When a subwoofer is connected to the rear output, set for subwoofer **S.W**.



Notes

- Even if you change this setting, there is no output unless you turn the subwoofer output on (refer to *Using subwoofer output* on page 40).
- If you change this setting, subwoofer output in the audio menu return to the factory settings.
- Both rear speaker leads outputs and RCA rear output are switched simultaneously in this setting.

Switching the sound muting/attenuation

Sound from this system is muted or attenuated automatically when the signal from the equipment with mute function is received.

- Sound from this system returns to normal when the muting or attenuation is canceled.

1 Touch NEXT on the initial menu.

2 Touch TEL to select any of the muting, attenuation or off.

Touch **TEL** until the desired setting appears in the display.

- **MUTE** – Muting
- **ATT-20dB** – Attenuation (**ATT-20dB** has a stronger effect than **ATT-10dB**)
- **ATT-10dB** – Attenuation
- **OFF** – Turn the sound muting/attenuation off



Notes

- The sound is turned off, **MUTE** is displayed and no audio adjustments are possible.
- The sound is attenuated, **ATT** is displayed and no audio adjustments, except volume control, are possible.
- Operation returns to normal when the phone connection is ended.

Switching the warning tone

If the front panel is not detached from the head unit within four seconds of turning off the ignition, a warning tone will sound. You can turn off the warning tone.

1 Touch NEXT on the initial menu.

Operating this unit

2 Touch **DT.WARNING** to turn warning tone on.

- To turn warning tone off, touch **DT.WARNING** again.

Setting the TV signal

When this unit is connected to a TV tuner, you need to adjust the TV signal suitable to your country TV signal setting.

- This function is initially set to **AUTO** so that this unit automatically adjusts the TV signal setting.
- About your country TV signal, consult with your nearest Pioneer dealer.

1 Touch **NEXT** on the initial menu.

2 Touch **TV SIGNAL** to select an appropriate TV signal.

Touching **TV SIGNAL** switches TV signal settings in the following order:

AUTO—PAL—NTSC—PAL-M—SECAM

Entering PIN code for Bluetooth wireless connection

To connect your cellular phone to this unit via Bluetooth wireless technology, you need to enter PIN code on your phone to verify the connection. The default code is **0000**, but you can change this in this function.

- With some Bluetooth audio players, you may be required to enter to this unit in advance PIN code of your Bluetooth audio player, in order to set this unit ready for a connection from your Bluetooth audio player.
- Only when Bluetooth adapter (e.g. CD-BTB100) is connected to this unit, you can operate this function.

1 Touch **NEXT** on the initial menu.

2 Touch **PINCODE INPUT**.

PIN code input display appears.

3 Touch **0 to 9** to input the PIN code of your Bluetooth audio player.

- To cancel the inputted numbers, touch **C**.

4 After inputting PIN code (up to 16 digits), touch **ENTER**.

The PIN code you entered is stored in this system.

Correcting distorted sound

You can minimize distortion that may be caused by the equalizer curve settings.

Setting an equalizer level high can cause distortion. If high sound is crippled or distorted, try switching to **LOW**. Normally, leave the setting at **HIGH** to ensure quality sound.

- Only when the multi-channel processor (e.g., DEQ-P7650) is connected to this unit, you can operate this function.

1 Touch **NEXT** on the initial menu.

2 Touch **DIGITAL ATT** to switch the digital attenuator setting.

Touch **DIGITAL ATT** repeatedly until the desired setting appears in the display.

- **HIGH** – High quality sound
- **LOW** – Minimize distortion sound

Resetting the audio functions

You can reset all audio functions except volume.

- Only when the multi-channel processor (e.g., DEQ-P7650) is connected to this unit, you can operate this function.

1 Touch **NEXT** twice on the initial menu.

2 Touch **AUDIO RESET**.

3 Touch **RESET**.

4 Touch **RESET** again to reset audio functions.

- To cancel resetting the audio functions, touch **CANCEL**.

Other Functions

Introduction of system adjustments

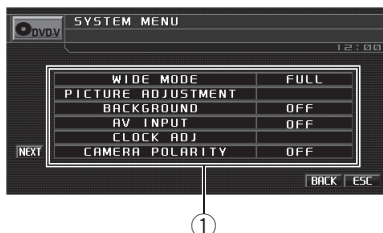

- ① System menu display
Shows the system function names.

1 Touch A.MENU and then touch SYSTEM MENU to display the system function names.

The system function names are displayed and operable ones are highlighted.

- To go to the next group of function names, touch **NEXT**.
- To return to the previous group of function names, touch **PREV**.

2 Touch ESC to return to the display of each source.

- To return to the previous display, touch **BACK**.

Changing the wide screen mode

You can select a desired mode for enlarging a 4:3 picture to a 16:9 one.

1 Touch WIDE MODE on the system menu.

2 Touch the desired wide mode setting.

3 Touch ESC to hide the touch panel keys.

Operating this unit

FULL (full)

A 4:3 picture is enlarged in the horizontal direction only, giving you a 4:3 TV picture (normal picture) without any omissions.

JUST (just)

The picture is enlarged slightly at the center and the amount of enlargement increases horizontally to the ends, enabling you to enjoy a 4:3 picture without sensing any disparity even on a wide screen.

CINEMA (cinema)

The picture is enlarged by the same proportion as **FULL** or **ZOOM** in the horizontal direction and by an intermediate proportion between **FULL** and **ZOOM** in the vertical direction; ideal for a cinema-sized picture (wide screen picture) where captions lie outside.

ZOOM (zoom)

A 4:3 picture is enlarged in the same proportion both vertically and horizontally; ideal for a cinema-sized picture (wide screen picture).

NORMAL (normal)

A 4:3 picture is displayed as it is, giving you no sense of disparity since its proportions are the same as that of the normal picture.



Notes

- Different settings can be memorized for each video source.
- When video is viewed in a wide screen mode that does not match its original aspect ratio, it may appear different.
- Remember that using the wide mode feature of this system for commercial or public viewing purposes may constitute an infringement on the author's rights protected by the Copyright Law.
- Video will appear grainy when viewed in **CINEMA** or **ZOOM** mode.

Changing the picture adjustment

You can adjust **BRIGHTNESS** (brightness), **CONTRAST** (contrast), **COLOR** (color) and **HUE** (hue) for each source and rear view camera.

- The adjustments of **BRIGHTNESS** and **CONTRAST** are stored separately for light ambient (daytime) and dark ambient (night-time). A sun ☀ or moon 🌙 is displayed to the left of **BRIGHTNESS** and **CONTRAST**, respectively, as the ambient light sensor determines brightness or darkness.
- You cannot adjust **COLOR** or **HUE** for the audio source.

1 Touch PICTURE ADJUSTMENT on the system menu.

The adjustment function names are displayed.

2 Touch any of the following touch panel keys to select the function to be adjusted.

- **BRIGHTNESS** – Adjust the black intensity
- **CONTRAST** – Adjust the contrast
- **COLOR** – Adjust the color saturation
- **HUE** – Adjust the tone of color (red is emphasized or green is emphasized)
- **DIMMER** – Adjust the brightness of display
- **REAR VIEW CAMERA/SOURCE** – Switch the picture adjustment modes
 - You cannot adjust the picture adjustment for rear view camera when **CAMERA POLARITY** is set to **OFF**. (Refer to *Setting for rear view camera (back up camera)* on page 53.)
 - With some rear view cameras, picture adjustment may not be possible.

3 Touch ◀ or ▶ to adjust the selected item.

Each time you touch ◀ or ▶ it increases or decreases the level of selected item. **+24** to **-24** is displayed as the level is increased or decreased.

4 Touch ESC to hide the touch panel keys.

Adjusting the dimmer

The adjustment of **DIMMER** is stored separately for each ambient light; daytime, evening and nighttime. The brightness of LCD screen will be adjusted to optimum level automatically in accordance with the ambient light based on the setting values.

- The icons indicating the current ambient brightness used for adjusting **BRIGHTNESS** and **CONTRAST** may differ from **DIMMER** slightly.

1 Touch PICTURE ADJUSTMENT on the system menu.

The adjustment function names are displayed.

2 Touch DIMMER.

The ambient light level used as the standard for adjusting **DIMMER** appears above the level bar.

- Red sun ☀ – Adjust the brightness for bright ambient light (daytime)
- Yellow sun 🌅 – Adjust the brightness for intermediate brightness (evening)
- Yellow moon 🌙 – Adjust the brightness for dark ambient light (nighttime)

3 Touch ◀ or ▶ to adjust the brightness.

Each time you touch ◀ or ▶ it moves cursor towards the left or the right.

The level indicates the brightness of the screen being adjusted. The farther cursor moves to the right, the brighter the screen.

4 Touch ESC to hide the touch panel keys.

Selecting the background display

You can switch background displays while listening to each source.

- You can enjoy **AV** (AV input) as the background video image while you are listening to audio source such as radio or CD.

- Touch **BACKGROUND** on the system menu to select the desired background display.

Audio source

BGP1 (background picture 1)—**BGP2** (background picture 2)—**BGP3** (background picture 3)—**AV** (AV input)

Video source

OFF (off)—**BGP1** (background picture 1)—**BGP2** (background picture 2)—**BGP3** (background picture 3)—**AV** (AV input)

- When the AV (AV input) is not set to **VIDEO**, **AV** cannot be selected. (Refer to this page.)

Setting the AV input

You can switch the setting according to the connected component.

- Select **VIDEO** to watch video of a connected component as **AV** source.
- Select **S-DVD** to watch video of a connected DVD player as **S-DVD** source.
- Select **EXT-VIDEO** to watch video of a connected video unit as **EXT** source.

- Touch **AV INPUT** on the system menu to select the AV input setting.

- **OFF** – No video component connected
- **VIDEO** – External video component (such as portable video player)
- **S-DVD** – DVD player connected with RCA cable
- **EXT-VIDEO** – External video unit (such as Pioneer products available in the future)
 - When a DVD player is connected with an AV-BUS cable, do not select **S-DVD** otherwise no picture will be displayed even if you select **S-DVD** as a source.

Setting the clock

Use these instructions to set the clock.

- 1 Touch **CLOCK ADJ** on the system menu.

Operating this unit

2 Touch ON/OFF to turn the clock display on.

- To turn the clock display off, touch **ON/OFF** again.

3 Touch ◀ or ▶ to select the segment of the clock display you wish to set.

Each time you touch ◀ or ▶ it will select one segment of the clock display:

Hour—Minute

As you select segments of the clock display the segment selected will be highlighted.

4 Touch ▲ or ▼ to put a clock right.



Notes

- You can match the clock to a time signal by touching **JUST**.
 - If the minute is **00** to **29**, the minutes are rounded down. (e.g., **10:18** becomes **10:00**.)
 - If the minute is **30** to **59**, the minutes are rounded up. (e.g., **10:36** becomes **11:00**.)
- Even when the sources are off, the clock display appears on the display.

Setting for rear view camera (back up camera)



CAUTION

Pioneer recommends the use of a camera which outputs mirror reversed images, otherwise screen image may appear reversed.

This unit features a function that automatically switches to the rear view camera video (**REAR VIEW CAMERA IN** jack) when a rear view camera is installed on your vehicle. When the gear shift is in **REVERSE (R)** position, the video automatically switches to a rear view camera video. (For more details, consult your dealer.)

- After you set up the rear view camera setting, move the gear shift in **REVERSE (R)** and confirm if a rear view camera video can be shown on the display.
- If the display should be switched to a rear view camera video by error while you are driving forward, change the rear view camera setting.
- To end watching a rear view camera video and return to the source display, press and hold **DISPLAY**.

● Touch CAMERA POLARITY on the system menu to select an appropriate setting.

- **BATTERY** – When the polarity of the connected lead is positive while the gear shift is in **REVERSE (R)** position
- **GROUND** – When the polarity of the connected lead is negative while the gear shift is in **REVERSE (R)** position
- **OFF** – When a rear view camera is not connected to this unit

Adjusting the LCD panel slide position

You can adjust the LCD panel slide position so that the panel is set back or forward.

1 Touch NEXT on the system menu.

2 Touch FLAP SET BACK to turn the set back on.

The LCD panel slides to the back.

- Touch **FLAP SET BACK** again to turn the set back off and the LCD panel slides to the front.

Setting the automatic open function

To prevent the display from hitting the shift lever of an automatic vehicle when it is in **P** (park) position, or when you do not wish the display to open/close automatically, you can set the automatic open function in the manual mode.

1 Touch **NEXT** on the system menu.

2 Touch **AUTO FLAP** to select the display to open/close automatically or manually.

Each time you touch **AUTO FLAP** it switches between the following settings:

- **ON** – The LCD panel will be opened or closed automatically with the turning of the ignition switch on or off
- **OFF** – You have to press **OPEN/CLOSE** to open/close the LCD panel

Switching the iPod charge setting

You can turn the iPod charge setting on or off while listening to an iPod.

- Listening AM radio while an iPod is charged from this unit may generate noise. In this case, turn the iPod charge setting off and noise is disappeared.

1 Touch **NEXT** on the system menu.

2 Touch **iPod CHARGE** to turn the iPod charge setting on.

- To turn the iPod charge setting off, touch **iPod CHARGE** again.



Note

To obtain maximum performance, we recommend that you use the latest version of the iPod software.

Adjusting the response positions of the touch panels (Touch Panel Calibration)

If you feel that the touch panel keys on the screen deviate from the actual positions that respond to your touch, adjust the response positions of the touch panel. There are two adjustment methods: 4-point adjustment, in which you touch four corners of the screen; and 16-point adjustment, in which you make fine-adjustments on the entire screen.

- Make sure to use the supplied pen for adjustment, and gently touch the screen. If you press the touch panel forcefully, the touch panel may be damaged. Do not use a sharp pointed tool such as ballpoint pen or a mechanical pen. Otherwise the screen is damaged.
- If touch panel adjustment cannot be performed properly, consult your local Pioneer dealer.

1 Touch the source icon and then touch **OFF** to turn this unit off.

- When the source icon is not displayed, you can display it by touching the screen.

2 Press and hold **BAND/ESC**.

The 4-point touch panel adjustment screen appears.

3 Touch each of the arrows on the four corners of the screen with the touch panel adjustment pen.

- To cancel the adjustment, press and hold **VOLUME/ATT**.

4 Press **BAND/ESC** to complete the 4-point adjustment.

The adjusted position data is saved.

- Do not turn off the engine while saving the adjusted position data.

Operating this unit

5 Press BAND/ESC to proceed to the 16-point adjustment.

The 16-point touch panel adjustment screen appears.

- To cancel the adjustment, press and hold **VOLUME/ATT**.

6 Gently touch the center of the + mark displayed on the screen with the touch panel adjustment pen.

After you touch all the marks, the adjusted position data is saved.

- Do not turn off the engine while saving the adjusted position data.

7 Press and hold VOLUME/ATT to complete the adjustment.

Using the AUX source

This unit can control an auxiliary equipment such as VCR or portable device (sold separately). When connected, auxiliary equipment is automatically recognized as AUX source and assigned to **AUX**.

About AUX connection method

You have two methods to connect auxiliary equipment to this unit.

Mini pin plug cable (AUX 1)

When connecting auxiliary equipment using a mini plug cable

iPod and portable audio/video player can be connected to this unit via mini plug cable.

- If an iPod with video capabilities is connected to this unit via 3.5 mm plug (4 pole) cable (e.g., CD-V150M), you can enjoy the video contents of the iPod.
- It is possible to connect a portable audio/video player by using a 3.5 mm plug (4 pole) to RCA cable, which is sold separately. However, depending on the cable, re-

verse connection between Red (right side audio) cable and yellow (video) cable is required. Otherwise, audio and video may not be correctly reproduced.

● Insert the mini plug into the microphone/auxiliary input jack on this unit.

For more details, refer to the installation manual.

IP-BUS-RCA interconnector (AUX 2)

When connecting auxiliary equipment using an IP-BUS-RCA Interconnector (sold separately)

● Use an IP-BUS-RCA Interconnector such as the CD-RB20/CD-RB10 (sold separately) to connect this unit to auxiliary equipment featuring RCA output.

For more details, refer to the IP-BUS-RCA Interconnector owner's manual.

- You can only make this type of connection if the auxiliary equipment has RCA outputs.

Selecting AUX as the source

● Touch the source icon and then touch **AUX 1/AUX 2** to select **AUX** as the source.

- If the auxiliary setting is not turned on, **AUX** cannot be selected. For more details, see *Switching the auxiliary setting* on page 47.

Setting the AUX title

The title displayed for the **AUX** source can be changed.

- Each title can be up to 10 characters long.

1 After you have selected **AUX** as the source, touch **A.MENU** and **FUNCTION MENU** and then touch **NAME EDIT**.

- When the touch panel keys are not displayed, you can display them by touching the screen.

Operating this unit

2 Touch ABC to select the desired character type.

Touch **ABC** repeatedly to switch between the following character types:
 Alphabet (upper case)—Alphabet (lower case)
 ■ You can select to input numbers and symbols by touching **123**.

3 Touch ▲ or ▼ to select a letter of the alphabet.

4 Touch ► to move the cursor to the next character position.

5 Touch OK to store the entered title in memory.

6 Touch ESC to return to the ordinary display.

● Press PGM and hold to turn BSSM on when selecting TV as the source.

Press **PGM** and hold until the BSSM turns on.
 ■ To cancel the storage process, press **PGM** again. 

Using the PGM button

You can operate the preprogrammed functions for each source by using **PGM**.

● Press PGM to turn pause on when selecting the following sources:

- **DVD** – Built-in DVD player
- **iPod** – iPod
- **USB** – USB portable audio player/USB memory
- **S-DVD** – DVD player/multi-DVD player
- **MCD** – Multi-CD player
- **BT Audio** – Bluetooth audio player
- To turn pause off, press **PGM** again.

● Press PGM and hold to turn BSM on when selecting RADIO as the source.

Press **PGM** and hold until the BSM turns on.
 ■ To cancel the storage process, press **PGM** again.

Available accessories

Playing songs on USB portable audio player/USB memory

Basic Operations

You can use this unit to control a USB adapter (e.g., CD-UB100), which is sold separately.

For details concerning operation, refer to the USB adapter's operation manual. This section provides information on USB portable audio player/USB memory operations with this unit which differs from that described in the USB adapter's operation manual.

- Optimum performance of this unit may not be obtained depending on the connected USB portable audio player/USB memory.

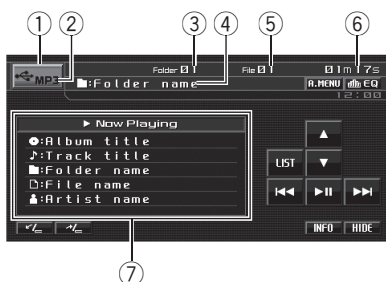

- ① Source icon
- ② Media indicator
Shows the type of file currently playing.
- ③ Folder number indicator
- ④ Folder name indicator
- ⑤ File number indicator
- ⑥ Play time indicator
- ⑦ Song information
Shows detailed information of currently playing song.

1 Touch the source icon and then touch USB to select the USB.

- When the source icon is not displayed, you can display it by touching the screen.

2 Touch ▲ or ▼ to select a folder.

- To return to folder 01 (ROOT), press and hold **BAND/ESC**. However, if folder 01 (ROOT) contains no files, playback commences with folder 02.

- You cannot select a folder that does not have a compressed audio file recorded in it.

3 To perform fast forward or reverse, keep touching ◀◀ or ▶▶.

4 To skip back or forward to another compressed audio file, briefly touch ◀◀ or ▶▶.

Pausing compressed audio playback

- Touch ▶|| during playback.
 - To resume playback at the same point that you turned pause on, touch ▶|| again.
 - If you perform track search during pause, text information such as album title, track title or folder name appear in blank.

Introduction of advanced operations

1 Touch A.MENU and then touch FUNCTION MENU to display the function names.

The function names are displayed and operable ones are highlighted.

2 Touch ESC to return to the playback display.

- To return to the previous display, touch **BACK**.

Function and operation

REPEAT, **RANDOM** and **SCAN** operations are basically the same as that of the built-in DVD player.

Function name	Operation
REPEAT	<p>Refer to <i>Repeating play</i> on page 33. But the repeat play ranges you can select are different from that of the built-in DVD player. The repeat play ranges of the USB portable audio player/USB memory are as below:</p> <ul style="list-style-type: none"> • FILE – Repeat just the current file • FOLDER – Repeat the current folder • ALL – Repeat all files
RANDOM	Refer to <i>Playing tracks in random order</i> on page 34.
SCAN	Refer to <i>Scanning tracks or folders</i> on page 34.



Notes

- If you select another folder during repeat play, the repeat play range changes to **ALL**.
- If you perform track search or fast forward/reverse during **FILE**, the repeat play range changes to **FOLDER**.
- When **FOLDER** is selected, it is not possible to play back a subfolder of that folder.
- After file or folder scanning is finished, normal playback of the files will begin again.

Displaying text information of an audio file

The operation is the same as that of the built-in DVD player.

Refer to *Text information* on page 32.

- If the characters recorded on the audio file are not compatible with this unit, those characters will not be displayed.

Selecting files from the file name list

The operation is the same as that of the built-in DVD player.

Refer to *Selecting files from the file name list* on page 33. 

Bluetooth Audio

Basic Operations

If you connect Bluetooth adapter (e.g. CD-BTB100) to this unit, you can control Bluetooth audio player via Bluetooth wireless technology.



Important

- Depending on the Bluetooth audio player connected to this unit, the available operations with this unit are limited to the following two levels:
 - Lower level: Only playing back songs on your audio player is possible.
 - Higher level: Playing back, pausing, selecting songs, etc., are possible (all the operations illustrated in this manual).
- Since there are a number of Bluetooth audio players available on the market, operations with your Bluetooth audio player using this unit vary in great range. Please refer to the instruction manual that came with your Bluetooth audio player as well as this manual while operating your player on this unit.
- Information about songs (e.g. the elapsed playing time, song title, song index, etc.) cannot be displayed on this unit.
- While you are listening to songs on your Bluetooth audio player, please refrain from operating on your cellular phone as much as possible. If you try operating on your cellular phone, the signal from your cellular phone may cause a noise on the song playback.
- When you are talking on the cellular phone connected to this unit via Bluetooth wireless technology, the song playback from your Bluetooth audio player connected to this unit is muted.
- Even if while you are listening to song on your Bluetooth audio player you switch to another source, the playback of song continues to elapse.

Available accessories

For details concerning operation, refer to the Bluetooth adapter's operation manual. This section provides brief information on Bluetooth audio player operations with this unit which slightly differs or is cut short from that described in the Bluetooth adapter's operation manual.

- Even though your audio player does not contain a Bluetooth module, you can still control it from this unit via Bluetooth wireless technology. To control your audio player by using this unit, connect a product featuring Bluetooth wireless technology (available on the market) to your audio player and connect Bluetooth adapter (e.g. CD-BTB100) to this unit.

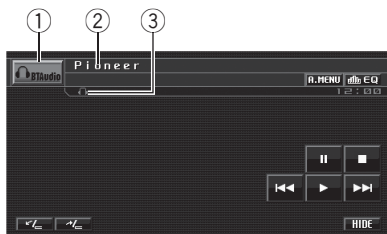

- ① Source icon
- ② Device name
Shows the device name of the connected Bluetooth audio player (or Bluetooth adapter).
- ③ Connection indicator
Shows the Bluetooth wireless connection status.

1 Touch the source icon and then touch BT Audio to select the Bluetooth audio source.

- For this unit to control your Bluetooth audio player it needs to establish a Bluetooth wireless connection. (Refer to *Connecting a Bluetooth audio player* on this page.)

2 Touch ►.

Playback starts.

3 To skip back or forward to another track, briefly touch ◀◀ or ▶▶.

4 To perform fast forward or reverse, keep touching ◀◀ or ▶▶.

5 To stop playback, touch ■.

Pausing playback

- Touch II during playback.
 - To resume playback at the same point that you turned pause on, touch ►.

Introduction of advanced operations

1 Touch A.MENU and then touch FUNCTION MENU to display the function names.

The function names are displayed and operable ones are highlighted.

2 Touch ESC to return to the ordinary display.

- To return to the previous display, touch BACK.

Connecting a Bluetooth audio player

● Touch CONNECTION OPEN on the function menu to turn the connection open on.

CONNECTION WAITING is displayed. This unit is now on standby for connection from Bluetooth audio player.

If your Bluetooth audio player is set ready for Bluetooth wireless connection, connection to this unit will be automatically established.

Note

Before you can use audio players you may need to enter the PIN code into this unit. If your player requires a PIN code to establish a connection, look for the code on the player or in its accompanying documentation. Enter the PIN code referring to *Entering PIN code for Bluetooth wireless connection* on page 49.

Disconnecting a Bluetooth audio player

- Touch **DISCONNECT** on the function menu.

After the disconnection is completed, **NO CONNECTION** is displayed.

Displaying BD (Bluetooth Device) address

- Touch **DEVICE INFO** on the function menu to display the BD address.

Various information regarding the Bluetooth wireless technology are displayed.

- **DEVICE NAME** (device name of this system)
- **BD ADDRESS** (address of Bluetooth device)
- **SYSTEM VERSION** (system version)
- **BT MODULE VERSION** (version of Bluetooth module) 

Bluetooth Telephone

Basic Operations

If you use Bluetooth adapter (e.g. CD-BTB100), you can connect a cellular phone featuring Bluetooth wireless technology to this unit for hands-free, wireless calls, even while driving.

Important

- Since this unit is on standby to connect with your cellular phones via Bluetooth wireless technology, using this unit without running the engine can result in battery drainage.
- Advanced operations that require your attention such as dialing numbers on the monitor, using phone book, etc., are prohibited while you are driving. When you need to use these advanced operations, stop your vehicle in a safe place and operate.

For details concerning operation, refer to the Bluetooth adapter's operation manual. This section provides brief information on the hands-free phoning operations with this unit which slightly differs or is cut short from that described in the Bluetooth adapter's operation manual.

- This unit is not compatible with registration for guest phone.
- This unit does not have the name edit function of a Phone Book entry.

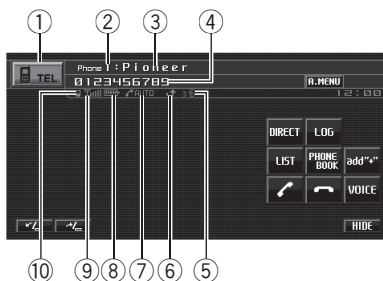

- ① Source icon
- ② User number indicator

Available accessories

- Shows the registration number of the cellular phone.
- ③ Device name
Shows the device name of the cellular phone.
- ④ Phone number
Shows the phone number you selected.
- ⑤ Voice recognition indicator
Shows when the voice recognition function is on (for more details, refer to *Voice recognition* on the next page).
- ⑥ Incoming call notice indication
Shows when an incoming call has been received and not checked yet.
 - Incoming call notice is not displayed for calls made when your cellular phone is disconnected from this unit.
- ⑦ Automatic answering/Automatic rejecting indicator
Shows when the automatic answering function is on (for more details, refer to *Setting the automatic answering* on page 67).
Shows when the automatic rejecting function is on (for more details, refer to *Setting the automatic rejecting* on page 67).
- ⑧ Battery strength indicator
Shows the battery strength of cellular phone.
 - Battery strength indicator may differ from the actual battery strength.
 - If the battery strength is not available, nothing is displayed in the battery strength indicator area.
- ⑨ Signal level indicator
Shows the signal strength of cellular phone.
 - Signal level indicator may differ from the actual signal level.
 - Depending on the cellular phones featuring Bluetooth wireless technology, radio field intensity is not available. In this case, the signal level indicator does not appear.
 - If your cellular phone is out of service, $\text{T} \times$ is displayed.
- ⑩ Telephone indicator
Shows when a phone connection using Bluetooth wireless technology is established (for

more details, refer to *Connecting a cellular phone* on the next page).

- While connecting automatically, telephone indicator is flashing.

● Touch the source icon and then touch TEL to select the telephone.



Note

Equalizer curve for the phone source is fixed. When selecting the phone source, you cannot operate the equalizer function. Refer to *Recalling equalizer curves* on page 38. When the multi-channel processor is connected to this unit, you can operate the equalizer function even when selecting the phone source. Refer to *Recalling equalizer curves* on page 82.

Setting up for hands-free phoning

Before you can use the hands-free phoning function you will need to set up the unit for use with your cellular phone. This entails establishing a Bluetooth wireless connection between this unit and your phone, registering your phone with this unit, and adjusting the volume level.

1 Connection

For detailed instructions on connecting your phone to this unit via Bluetooth wireless technology, refer to *Connecting a cellular phone* on the next page.

- Your phone should now be temporarily connected; however, to make best use of the technology, we recommend you register the phone to this unit.

2 Registration

To register your temporarily connected phone, refer to *Registering connected cellular phone* on page 63.

3 Volume adjustment

Adjust the earpiece volume on your cellular phone for comfort. When adjusted, the volume level is memorized in this unit as the default setting.

- Caller's voice volume and ring volume may vary depending on the type of cellular phones.
- If the difference between the ring volume and caller's voice volume is big, overall volume level may become unstable.
- Before disconnecting cellular phone from this unit, make sure to adjust the volume to proper level. If the volume has been muted (zero level) on your cellular phone, the volume level of your cellular phone remains muted even after the cellular phone is disconnected from this unit.

Making a phone call

Voice recognition

1 Touch VOICE to turn the voice recognition function on.

Voice dial icon appears on the information bar. Voice recognition function is now ready.

- To cancel the voice recognition function, touch VOICE again.

2 Pronounce the name of your contact.

Taking a phone call

Answering an incoming call

1 When a call comes in, touch .

- You can also perform this operation by pressing .
- If the private mode is selected on the cellular phone, hands-free phoning may not be performed.

2 To end the call, touch .

- You can also perform this operation by pressing .

Rejecting an incoming call

● When a call comes in, touch .

The call is rejected.

Answering a call waiting

1 Touch to answer a call waiting.

2 Touch to end all calls.

- The caller you have been talking to is now on hold. To end the call, both you and your caller need to hang up the phone.
- While your callers hold the line, touching  switches between callers.

Rejecting a call waiting

● Touch to reject a call waiting.

Introduction of advanced operations

1 Touch A.MENU and then touch FUNCTION MENU to display the function names.

The function names are displayed and operable ones are highlighted.

2 Touch ESC to return to the telephone standby display.

- To return to the previous display, touch BACK.

Connecting a cellular phone

Searching for available cellular phones

1 Touch PHONE CONNECT on the function menu.

Available accessories

2 Touch SEARCH to search for available cellular phones.

While searching, **SEARCHING** flashes. When available cellular phones featuring Bluetooth wireless technology are found, device names or **Name Not Found** (if names cannot be obtained) are displayed.

- If this unit fails to find any available cellular phones, **NOT FOUND** is displayed.
- You can display the BD address by touching **BD ADDR**. To return to the device name, touch **PHONE NAME**.

3 Touch the device name you want to connect.

While connecting, **CONNECTING** flashes. To complete the connection, please check the device name (**Pioneer BT unit2**) and enter the link code on your cellular phone. If the connection is established, **CONNECTED** is displayed.

- The link code is set to **0000** as default. You can change this code in the initial setting. Refer to *Entering PIN code for Bluetooth wireless connection* on page 49.

Using a cellular phone to initiate a connection

1 Touch PHONE CONNECT on the function menu.

2 Touch CONNECTION OPEN.

CONNECTION WAITING flashes and the unit is now on standby for connection from cellular phone.

3 Use cellular phone to connect to this unit.

- To cancel this function, touch **CONNECTION OPEN** again.
- The link code is set to **0000** as default. You can change this code in the initial setting. Refer to *Entering PIN code for Bluetooth wireless connection* on page 49.

Disconnecting a cellular phone

1 Touch PHONE CONNECT on the function menu.

2 Touch DISCONNECT to disconnect the currently connected cellular phone from this unit.

After the disconnection is completed, **NO CONNECTION** is displayed.

Registering connected cellular phone

1 Touch PHONE REGISTER on the function menu.

Registration assignments for user phone 1, 2 and 3 appear on the display.

2 Touch and hold one of the registration assignments to register the currently connected phone.

If the registration is succeeded, the device name of the connected phone is displayed in the selected assignment.

- If the assignment is empty, the device name is not displayed. If the assignment is already taken, the device name appears. To replace an assignment with a new phone, first delete the current assignment. For more detailed instructions, see *Deleting a registered phone* on this page.
- If the registration failed, device name of the connected phone is not displayed in the selected assignment. In this case, return to step 1 and try again.

Deleting a registered phone

1 Touch PHONE REGISTER on the function menu.

2 Touch DELETE next to the device name you want to delete.

A confirmation display appears. Touch **OK** to delete the phone.

- To cancel deleting a registered phone, touch **CANCEL**.

Connecting to a registered cellular phone

Connecting to a registered phone manually

1 Touch PHONE CONNECT on the function menu.

2 Touch DIRECT CONNECT.

3 Touch the device name you want to connect.

While connecting, **CONNECTING** is flashing. If the connection is established, **CONNECTED** is displayed.

Connecting to a registered phone automatically

1 Touch NEXT on the function menu.

2 Touch AUTO CONNECT to turn the Automatic Connection function on.

If your cellular phone is set ready for Bluetooth wireless connection, the connection to this unit will be automatically established.

- To turn automatic connection off, touch **AUTO CONNECT** again.

Using the Phone Book

Transferring entries to the Phone Book

The Phone Book can hold a total of 500 entries; 300 from User 1, 150 from User 2, and 50 from User 3.

1 Touch PHONE BOOK TRANSFER on the function menu.

2 Touch START to turn the Phone Book Transfer function on.

The Phone Book Transfer is now on standby.

3 Use cellular phone to perform phone book transfer.

Perform phone book transfer using the cellular phone. For detailed instruction on this, refer to the instruction manual that came with your cellular phone.

- The display indicates how many entries have been transferred and the total number to be transferred.
- To cancel the transferring process, touch **STOP**.

4 When you are done transferring Phone Book entries, touch ESC.



Note

When the phone book transfer is complete, the connection to your cellular phone is off. To use the Phone Book, connect to your cellular phone once again, referring to *Connecting to a registered cellular phone* on this page.

Changing the Phone Book display order

● Touch PHONE BOOK NAME VIEW on the function menu to change the name view order.

INVERTED is displayed and the name view order is changed.

- To change to the other display order, touch **PHONE BOOK NAME VIEW** again.

Available accessories

Calling a number in the Phone Book

Important

To perform this operation, be sure to park your vehicle and apply the parking brake.

1 Touch **PHONE BOOK** to display the Phone Book.

2 Touch **▲** or **▼** to select the first letter of the name you are looking for.

Touching **▲** or **▼** changes alphabetical letters.

3 Touch **ENTER** to show entries starting with the letter you chose.

The display shows the first six Phone Book entries starting with that letter (e.g. "Ben", "Brian" and "Burt" when "B" is selected).

- Touch **↕** or **↘** to display other phone book entries.
- To refine the search with a different letter, touch **CLEAR**.

4 Touch a Phone Book entry you want to call.

The display is switched to the Phone Book detail display.

5 Touch phone number of the Phone Book entry you want to call.

If several phone numbers are entered to an entry, touch one you want to call.

The display returns to the normal display and the Phone Book entry you selected is displayed on the information bar.

6 Touch **☎** to make a call.

- For an international call, touch **add "+"** to add + to the phone number.

7 To end the call, touch **⏏**.

Editing phone numbers

Important

To perform this operation, be sure to park your vehicle and apply the parking brake.

You can edit the numbers of Phone Book entries. Each phone number can be up to 24 digits long.

1 Touch **PHONE BOOK** to display the Phone Book.

2 Select a Phone Book entry you want to edit.

See step two to four on *Calling a number in the Phone Book* on this page for how to do this.

3 Touch **EDIT** next to the phone number you want to edit.

The display is changed to the Phone Book dial edit display.

4 Touch **0** to **9** to input numbers.

- For an international call, touch **add "+"** to add + to the phone number.
- Touch **CLEAR** to delete the number. Touch and hold **CLEAR** to delete all the input numbers.

5 Touch **OK** to store the new number.

Clearing a Phone Book entry

Important

To perform this operation, be sure to park your vehicle and apply the parking brake.

1 Touch **PHONE BOOK** to display the Phone Book.

2 Select a Phone Book entry you want to delete.

See step two to four on *Calling a number in the Phone Book* on this page for how to do this.

3 Touch DELETE to delete the Phone Book entry.

A confirmation display appears. Touch **YES** to delete the entry.

- If you do not want to clear a Phone Book entry that you have selected, touch **NO**.

Using the Call History

Important

To perform this operation, be sure to park your vehicle and apply the parking brake.

The 6 most recent calls made (dialled), received and missed, are stored in the Call History. You can browse the Call History and call numbers from it.

1 Touch LOG to display the Call History.

Touching **LOG** repeatedly switches between the following call histories:

MISSED CALL LIST (missed call)—

DIALED CALL LIST (dialled call)—

RECEIVED CALL LIST (received call)

- You can switch between phone number and name (if entered) by touching **ABC/123**.
- If no phone numbers have been stored in the selected list, nothing is displayed.

2 Touch a phone number or name (if entered) you want to call.

The display returns to the normal display and the phone number you selected is displayed on the information bar.

3 Touch to make a call.

- For an international call, touch **add “+”** to add + to the phone number.

4 To end the call, touch .

Using preset numbers

Important

To perform this operation, be sure to park your vehicle and apply the parking brake.

Assigning preset numbers

Numbers that you dial frequently can be assigned to presets for quick recall.

You can assign up to 6 frequently called phone numbers to number presets.

1 Select a desired phone number from the Phone Book or the Call History. Or directly enter a desired phone number.

To select a desired phone number from the Phone Book or the Call History, see the instructions explained in previous pages. To directly enter a desired phone number, see *Making a call by entering phone number* on the next page.

The display should now be the normal display and the selected phone number is displayed on the information bar.

2 Touch LIST to display preset assignments.

Preset assignments appear in the display (if not displayed yet).

3 Keep touching one of preset assignments to store the phone number.

The phone number you selected is stored in presets.

- **No Data** is displayed for empty assignment. Even if the assignment is taken, you can replace it to the new one by keeping touching the assignment.

Recalling preset numbers

1 Touch LIST to display preset assignments.

Preset assignments appear in the display (if not displayed yet).

Available accessories

2 Touch one of preset assignments.

The selected phone number should now be displayed on the information bar.

3 Touch to make a call.

4 To end the call, touch .

Making a call by entering phone number

Important

To perform this operation, be sure to park your vehicle and apply the parking brake.

1 Touch **DIRECT** to display the direct dial display.

2 Touch 0 to 9 to input numbers.

- For an international call, touch **add “+”** to add + to the phone number.
- Touch **CLEAR** to delete the number. Touch and hold **CLEAR** to delete all the input numbers.
- Up to 24 digits can be entered.
- If you want to store the entered phone number to preset assignment, touch **SET** here. The display returns to the normal display and the phone number you entered is selected.

3 When you completed entering the number, touch to make a call.

4 To end the call, touch .

Clearing memory

1 Touch **CLEAR MEMORY** on the function menu.

2 Touch **CLEAR** next to the item you want to delete from the memory.

Select from the following:

- **PHONE BOOK** (phone book)
- **DIALED CALLS** (dialled call history)
- **RECEIVED CALLS** (received call history)

- **MISSED CALLS** (missed call history)
- **DIAL PRESET** (preset phone numbers)

After selecting a desired item, a confirmation display appears. Touch **OK** to delete the memory.

- If you do not want to clear memory that you have selected, touch **CANCEL**.
- If you want to clear all the Phone Book, dialled/received/missed call history list and preset phone number, touch **CLEAR ALL**.

Setting the automatic answering

● Touch **AUTO ANSWER** on the function menu to turn the automatic answer on.

- To turn the automatic answer off, touch **AUTO ANSWER** again.

Setting the automatic rejecting

1 Touch **NEXT** on the function menu.

2 Touch **REFUSE ALL CALLS** to turn the automatic call rejection on.

- To turn the automatic call rejection off, touch **REFUSE ALL CALLS** again.

Switching the ring tone

1 Touch **NEXT** on the function menu.

2 Touch **RING TONE** to turn the ring tone on.

- To turn the ring tone off, touch **RING TONE** again.

Echo canceling and noise reduction

1 Touch **NEXT** on the function menu.

2 Touch **ECHO CANCEL** to turn Echo Cancel function on.

- To turn echo canceling off, touch **ECHO CANCEL** again.

Displaying BD (Bluetooth Device) address

Displaying BD address of this system

1 Touch **NEXT** on the function menu.

2 Touch **DEVICE INFO** to display the **BD address**.

Various information regarding the Bluetooth wireless technology are displayed.

- **DEVICE NAME** (device name of this system)
- **BD ADDRESS** (address of Bluetooth device)
- **SYSTEM VERSION** (version of this unit's microprocessor)
- **BT MODULE VERSION** (version of Bluetooth module)

Displaying BD address of your cellular phone

1 Touch **PHONE CONNECT** on the function menu.

2 Touch **BD ADDRESS** to display the **BD address**.

12-digit hexadecimal string is displayed.

- To return to the device name, touch

PHONE NAME.

Multi-CD Player

Basic Operations

You can use this unit to control a multi-CD player, which is sold separately.

- This unit does not have *ITS* playlist, disc title and track title list functions.
- Only those functions described in this manual are supported by 50-disc multi-CD players.
- This unit is not designed to operate disc title list functions with a 50-disc multi-CD player.

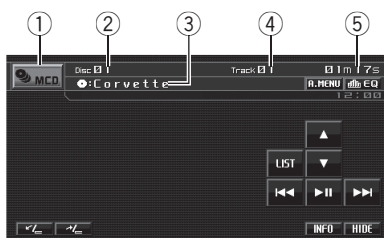

- ① Source icon
- ② Disc number indicator
- ③ Disc title indicator
Shows the title of the currently playing disc only when playing CD TEXT discs.
- ④ Track number indicator
- ⑤ Play time indicator

1 Touch the **source icon** and then touch **MCD** to select the multi-CD player.

2 Touch **▲** or **▼** to select a disc.

3 To skip back or forward to another track, briefly touch **◀◀** or **▶▶**.

- You can also skip back or forward to another track by pressing **◀◀** or **▶▶**.

4 To perform fast forward or reverse, keep touching **◀◀** or **▶▶**.

- You can also perform fast reverse/fast forward by pressing and holding **◀◀** or **▶▶**.

Available accessories



Notes

- When the multi-CD player performs the preparatory operations, **READY** is displayed.
- If an error message such as **ERROR-02-XX** is displayed, refer to the multi-CD player owner's manual.
- If there are no discs in the multi-CD player magazine, **NO DISC** is displayed.

Selecting a disc

1 Touch LIST.

2 Touch your favorite disc.

Selectable discs are highlighted.

3 Touch ESC to return to the ordinary display.

Pausing CD playback

- Touch **▶II** during playback.
 - To resume playback at the same point that you turned pause on, touch **▶II** again.

Introduction of advanced operations

You can use these functions only with a multi-CD player that supports them.

1 Touch A.MENU and then touch FUNCTION MENU to display the function names.

The function names are displayed and operable ones are highlighted.

2 Touch ESC to return to the playback display.

- To return to the previous display, touch **BACK**.

Function and operation

REPEAT, RANDOM, SCAN and **COMPRESSION** operations are basically the same as that of the built-in DVD player.

Function name	Operation
REPEAT	Refer to <i>Repeating play</i> on page 33. But the repeat play ranges you can select are different from that of the built-in DVD player. The repeat play ranges of the multi-CD player are as below: <ul style="list-style-type: none"> • MULTI-CD – Repeat all discs in the multi-CD player • TRACK – Repeat just the current track • DISC – Repeat the current disc
RANDOM	Refer to <i>Playing tracks in random order</i> on page 34.
SCAN	Refer to <i>Scanning tracks or folders</i> on page 34.
COMPRESSION	Refer to <i>Using compression</i> on page 35. Multi-CD player has COMP (compression) and DBE (dynamic bass emphasis) functions. The settings can be switched as below: OFF—COMP1—COMP2—OFF—DBE 1—DBE 2



Notes

- If you select other discs during repeat play, the repeat play range changes to **MULTI-CD**.
- If you perform track search or fast forward/reverse during **TRACK**, the repeat play range changes to **DISC**.
- After track or disc scanning is finished, normal playback of the tracks will begin again.
- If the multi-CD player does not support COMP/DBE, you cannot operate this function.

Using CD TEXT functions

You can use these functions only with a CD TEXT compatible multi-CD player.

The operation is the same as that of the built-in DVD player.

Refer to *Text information* on page 32. 

DVD Player

Basic Operations

You can use this unit to control a DVD player or multi-DVD player, which is sold separately.

For details concerning operation, refer to the DVD player's or multi-DVD player's operation manual. This section provides information on DVD operations with this unit which differs from that described in the DVD player's or multi-DVD player's operation manual.

- This unit does not have ITS playlist and disc title functions.
- Switch the remote control selection to suitable setting to operate DVD players. (Refer to page 46.)
- Switch the remote control operation mode to **DVD** to operate the DVD player by using remote control. (Refer to page 19.)

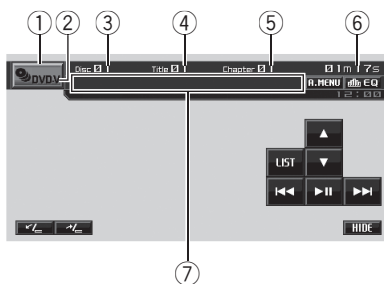

- ① Source icon
- ② Media indicator
- ③ Disc number indicator
Shows the disc number currently playing when using a multi-DVD player.
- ④ Title/Folder number indicator
- ⑤ Chapter/track number indicator
- ⑥ Play time indicator
- ⑦ Variable message area
Shows the text information of disc currently playing when playing a compressed audio disc.

Available accessories

- This unit cannot display the text information recorded on a CD TEXT disc playing on the optional DVD player.

1 Touch the source icon and then touch S-DVD to select the DVD player.

- When the source icon is not displayed, you can display it by touching the screen.

2 Touch the screen to display the touch panel keys.

3 To skip back or forward to another chapter/track, briefly touch ◀◀ or ▶▶.

- You can also skip back or forward to another chapter/track by pressing ◀◀ or ▶▶.

4 To perform fast forward or reverse, keep touching ◀◀ or ▶▶.

- You can also perform fast reverse/fast forward by pressing and holding ◀◀ or ▶▶.

Note

If you do not use the touch panel keys within 30 seconds, they will be hidden automatically when playing DVD video or Video CD.

Turning the DVD player on or off

- Only the remote control can operate this function. To perform this function, switch the remote control operation mode to **DVD**. (Refer to page 19.)

● Press REAR SOURCE to turn the DVD player on.

- To turn the DVD player off, press **REAR SOURCE** again.

Selecting a disc

- You can operate this function only when a multi-DVD player is connected to this unit.

1 Touch LIST.

2 Touch your favorite disc.

Selectable discs are highlighted.

3 Touch ESC to return to the ordinary display.

Note

You can also select a disc by keeping touching ▲ or ▼.

Selecting a folder

- You can operate this function only when a DVD player which is corresponding to compressed audio playback is connected to this unit.

- Touch ▲ or ▼ to select a folder.

Pausing disc playback

- Touch ▶|| during playback.
 - To resume playback at the same point that you turned pause on, touch ▶|| again.

Introduction of advanced operations

1 Touch A.MENU and then touch FUNCTION MENU to display the function names.

The function names are displayed and operable ones are highlighted.

2 Touch ESC to return to the playback display.

- To return to the previous display, touch **BACK**.

Function and operation

REPEAT, **RANDOM** and **SCAN** operations are basically the same as that of the built-in DVD player.

Function name	Operation
REPEAT	<p>Refer to <i>Repeating play</i> on page 33. But the repeat play range that you can select is vary depending on the type of disc or system. The repeat play ranges of the DVD player/multi-DVD player are as below:</p> <p>During PBC playback of Video CDs, this function cannot be operated.</p> <ul style="list-style-type: none"> • DISC – Repeat the current disc • FOLDER – Repeat the current folder • TITLE – Repeat just the current title • CHAPTER – Repeat just the current chapter • TRACK – Repeat just the current track
RANDOM	Refer to <i>Playing tracks in random order</i> on page 34.
SCAN	Refer to <i>Scanning tracks or folders</i> on page 34.

Notes

- If you select other discs during repeat play, the repeat play range changes to **DISC**.
- When playing back Video CD or CD, if you perform track search or fast forward/reverse during **TRACK**, the repeat play range changes to **DISC**.
- When playing back compressed audio, if you select another folder during repeat play, the repeat play range changes to **DISC**.
- When playing back compressed audio, if you perform track search or fast forward/reverse during **TRACK**, the repeat play range changes to **FOLDER**.

Displaying text information of an audio file

The operation is the same as that of the built-in DVD player.

Refer to *Text information* on page 32.

- If the characters recorded on the audio file are not compatible with this unit, those characters will not be displayed.

Selecting files from the file name list

- You can operate this function only when a DVD player which is corresponding to compressed audio playback is connected to this unit.

1 Touch LIST to display the list of folder and file names.

DISC LIST (disc list)—**FOLDER&FILE LIST** (folder and file list)

2 Select the desired file name (or folder name).

The operation is the same as that of the built-in DVD player.

Refer to *Selecting files from the file name list* on page 33. 

Available accessories

TV tuner

Basic Operations

You can use this unit to control a TV tuner (e.g. GEX-P5750TV(P)), which is sold separately.

For details concerning operation, refer to the TV tuner's operation manual. This section provides information on TV operations with this unit which differs from that described in the TV tuner's operation manual.

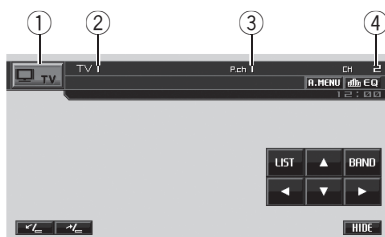

- ① Source icon
- ② Band indicator
- ③ Preset number indicator
- ④ Channel indicator

1 Touch the source icon and then touch TV to select the TV.

- When the source icon is not displayed, you can display it by touching the screen.

2 Touch the screen to display the touch panel keys.

3 Touch BAND to select a band.

Touch **BAND** repeatedly until the desired band is displayed, **TV1** or **TV2**.

4 To perform manual tuning, briefly touch ◀ or ▶.

- You can also perform manual tuning by pressing **◀◀** or **▶▶**.

5 To perform seek tuning, keep touching ◀ or ▶ for about one second and release.

The tuner will scan the channels until a broadcast strong enough for good reception is found.

- You can cancel seek tuning by briefly touching either ◀ or ▶.
- If you keep touching ◀ or ▶ you can skip broadcasting channels. Seek tuning starts as soon as you release the keys.
- You can also perform seek tuning by pressing and holding **◀◀** or **▶▶**.



Note

If you do not use the touch panel keys within 30 seconds, they will be hidden automatically.

Storing and recalling broadcast stations

If you touch any of the preset tuning keys **P01** to **P12** you can easily store up to 12 broadcast stations for later recall with the touch of a key.

- Up to 24 stations, 12 for each of two TV bands, can be stored in memory.

1 Touch LIST to display the preset list.

- When the touch panel keys are not displayed, you can display them by touching the screen.

2 When you find a station that you want to store in memory, keep touching one of preset tuning keys P01 to P12 until the beep sounds.

The next time you touch the same preset tuning key the station is recalled from memory.

- To switch between **P01** to **P06** and **P07** to **P12**, touch **PREV** or **NEXT**.

3 Touch ESC to return to the ordinary display.

**Note**

You can also use ▲ and ▼ to recall stations assigned to preset tuning keys **P01** to **P12**.

Introduction of advanced operations

1 Touch **A.MENU** and then touch **FUNCTION MENU** to display the function names.

The function names are displayed and operable ones are highlighted.

2 Touch **ESC** to return to the TV picture.

- To return to the previous display, touch **BACK**.

Storing the strongest broadcast stations sequentially

● Touch **BSSM** on the function menu to turn **BSSM** on.

BSSM begins to flash. While **BSSM** is flashing the 12 strongest broadcast stations will be stored in order from the lowest channel up. When finished, **BSSM** stops flashing.

- To cancel the storage process, touch **BSSM** again.

**Note**

Storing broadcast stations with **BSSM** may replace broadcast stations you have saved using **P01** to **P12**.

Selecting the area group

1 Touch **COUNTRY** on the function menu.

2 Touch ◀ or ▶ to select the area group.

Touch ◀ or ▶ until the desired area group appears in the display.

COUNTRY1 (CCIR channel)—**COUNTRY2** (IN channel)—**COUNTRY3** (CHN channel)—**COUNTRY4** (U.K. channel)—**COUNTRY5** (OIRT channel)—**COUNTRY6** (AUSTRALIA channel)—**COUNTRY7** (SAF channel)

Available accessories

Digital Signal Processor

Introduction of DSP adjustments

You can use this unit to control multi-channel processor (e.g. DEQ-P7650), which is sold separately.

- Some functions may differ depending on the multi-channel processor connected to this unit.

Important

When a multi-channel processor and an optional DVD player are connected to this unit, be sure to use an optical cable (e.g., CD-AD600).

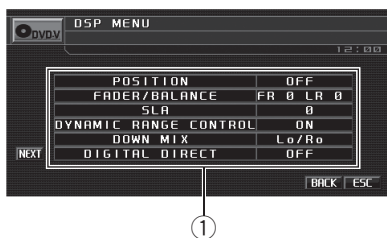

① DSP display

Shows the DSP function names.

By carrying out the following settings/adjustments in the order shown, you can create a finely-tuned sound field effortlessly.

- 1 *Setting the speaker setting*
- 2 *Using the position selector*
- 3 *Auto TA and EQ (auto-time alignment and auto-equalizing)*
- 4 *Adjusting the time alignment*
- 5 *Adjusting the speaker output levels using a test tone*
- 6 *Selecting a cross-over frequency*
- 7 *Adjusting the speaker output levels*
- 8 *Adjusting 3-band parametric equalizer*

1 Touch A.MENU and then touch DSP MENU to display the DSP function names.

The DSP function names are displayed and operable ones are highlighted.

- To go to the next group of function names, touch **NEXT**.
- To return to the previous group of function names, touch **PREV**.
- When playing discs recorded with more than 96 kHz sampling frequency, you cannot use audio functions. Also, equalizer curve setting, **POSITION**, **AUTO EQ** and **AUTO TA** will be cancelled.
- When playing discs recorded with more than 96 kHz sampling frequency, audio is outputted from front speakers only.
- When selecting the FM as the source, you cannot switch to **SLA**.
- When playing other than the DVD disc, you cannot switch to **DYNAMIC RANGE CONTROL**.
- When neither **FRONT-L** nor **FRONT-R** is selected in **POSITION**, you cannot switch to **TIME ALIGNMENT**.
- When both the center speaker and the rear speaker are set to OFF in the speaker setting, you cannot switch to **DOLBY PRO LOGIC II**.

2 Touch ESC to return to the ordinary display.

- To return to the previous display, touch **BACK**.

Using the sound field control

The SFC function creates the sensation of a live performance.

- The acoustics of different performance environments are not the same and depend on the extent and contour of space through which sound waves move and on how sounds bounce off the stage, walls, floors and ceilings. At a live performance you hear music in three stages: direct sound, early reflections, and late reflections, or reverberations. Those factors are programmed into the SFC circuitry to recreate the acoustics of various performance settings.

1 On the normal display, touch EQ and hold to switch to SFC function.

Touch **EQ** and hold until **SFC** appears in the display.

- To switch to equalizer function, touch **SFC** and hold.

2 Touch SFC to select the desired SFC mode.

Touch **SFC** repeatedly to switch between the following modes:

MUSICAL (musical)—**DRAMA** (drama)—**ACTION** (action)—**JAZZ** (jazz)—**HALL** (hall)—**CLUB** (club)—**OFF** (off)

Note

If the source is a 2-channel LPCM audio or a 2-channel Dolby Digital audio and you select SFC effects that are most applicable for 5.1-channel audio (i.e., **MUSICAL**, **DRAMA** or **ACTION**), we recommend turning Dolby Pro Logic II on. On the other hand, when selecting SFC effects that are intended for use with 2-channel audio (i.e., **JAZZ**, **HALL** or **CLUB**), we recommend turning Dolby Pro Logic II off.

Using the position selector

One way to assure a more natural sound is to accurately position the stereo image, putting you right in the center of the sound field. The position selector function lets you automati-

cally adjust the speaker output levels and inserts a delay time to match the number and position of occupied seats. When used in conjunction with the SFC, the feature will make the sound image more natural and offer a panoramic sound that envelops you.

1 Touch POSITION on the DSP function menu.

2 Touch ◀/▶/▲/▼ to select a listening position.

Touch one of these, ◀/▶/▲/▼, to select a listening position as listed in the table.

Key	Display	Position
◀	FRONT-L	Front seat left
▶	FRONT-R	Front seat right
▲	FRONT	Front seats
▼	ALL	All seats

- To cancel the selected listening position, touch the same key again.

Note

When you make adjustments to the listening position, the speaker outputs are automatically set for appropriate levels. You can tailor the levels more precisely referring to *Adjusting the speaker output levels using a test tone* or *Adjusting the speaker output levels*.

Using balance adjustment

You can change the fader/balance setting so that it can provide you an ideal listening environment in all occupied seats.

1 Touch FADER/BALANCE on the DSP function menu.

Available accessories

2 Touch ▲ or ▼ to adjust front/rear speaker balance.

Each time you touch ▲ or ▼ it moves the front/rear speaker balance towards the front or the rear.

FRONT:25 to **REAR:25** is displayed as the front/rear speaker balance moves from front to rear.

- **FR: 0** is the proper setting when only two speakers are used.

3 Touch ◀ or ▶ to adjust left/right speaker balance.

Each time you touch ◀ or ▶ it moves the left/right speaker balance towards the left or the right.

LEFT:25 to **RIGHT:25** is displayed as the left/right speaker balance moves from left to right.

Adjusting source levels

SLA (source level adjustment) lets you adjust the volume level of each source to prevent radical changes in volume when switching between sources.

- Settings are based on the FM volume level, which remains unchanged.

1 Compare the FM volume level with the level of the source you wish to adjust.

2 Touch SLA on the DSP function menu.

3 Touch ◀ or ▶ to adjust the source volume.

Each time you touch ◀ or ▶ it increases or decreases the source volume.

+4 to **-4** is displayed as the source volume is increased or decreased.



Notes

- The AM volume level can also be adjusted with source level adjustments.

- Video CD, CD, compressed audio and DivX are set to the same source level adjustment volume automatically.
- DVD and the optional DVD player are set to the same source level adjustment volume automatically.
- External unit 1 and external unit 2 are set to the same source level adjustment volume automatically.
- AUX (auxiliary input) and AV (AV input) are set to the same source level adjustment volume automatically.

Using the dynamic range control

The dynamic range refers to the difference between the largest and softest sounds. The dynamic range control compresses this difference so that you can clearly hear sounds even at low volume levels.

- The dynamic range control is effective only on Dolby Digital sounds.
- When playing other than the DVD disc, you cannot switch to

DYNAMIC RANGE CONTROL.

1 Touch DYNAMIC RANGE CONTROL on the DSP function menu.

2 Touch ▶ to turn the dynamic range control on.

- To turn dynamic range control off, touch ◀.

Using the down-mix function

The down-mix function allows you to play back multi-channel audio in 2 channels.

1 Touch DOWN MIX on the DSP function menu.

2 Touch ◀ or ▶ to select the desired level.

- **Lo/Ro** – Stereo mix the original audio that do not contain channel modes such as surround components.
- **Lt/Rt** – Down mix so that the surround components can be restored (decoded).

Using the direct control

You can override audio settings to check for effectiveness of your audio settings.

- All audio functions are locked out when the direct control is on except **VOLUME/ATT** and **DOLBY PRO LOGIC II**.

1 Touch DIGITAL DIRECT on the DSP function menu.

2 Touch ▶ to turn the direct control on.

- To turn direct control off, touch ◀.

Using the Dolby Pro Logic II

Dolby Pro Logic II creates five full-bandwidth output channels from two-channel sources to achieve high-purity matrix surround.

- Dolby Pro Logic II supports up to 48kHz sampling rate stereo source and has no effect on other types of source.
- When both the center speaker and the rear speaker are set to OFF in the speaker setting, you cannot switch to **DOLBY PRO LOGIC II**.

1 Touch NEXT on the DSP function menu.

2 Touch DOLBY PRO LOGIC II.

3 Touch any of the following touch panel keys to select the desired mode.

- **MOVIE** – The Movie mode suitable for movie playback
- **MUSIC** – The Music mode suitable for music playback

- **MATRIX** – The Matrix mode for when FM radio reception is weak
- **OFF** – Turn Dolby Pro Logic II off
- **MUSIC ADJUST** – Adjust the Music mode
 - You can operate **MUSIC ADJUST** only when **MUSIC** has been selected.

Adjusting the Music mode

You can adjust the Music mode with the following three controls.

- Panorama (**PANORAMA**) extends the front stereo image to include the surround speakers for an exciting “wraparound” effect.
- Dimension (**DIMENSION**) allows you to gradually adjust the sound field either towards the front or the rear.
- Center Width Control (**CENTER WIDTH**) allows center-channel sounds to be positioned between the center speaker and the left/right speakers. It improves the left-center-right stage presentation for both the driver and the front passenger.

1 Touch NEXT on the DSP function menu.

2 Touch DOLBY PRO LOGIC II.

3 Touch MUSIC and then touch MUSIC ADJUST.

- You can operate **MUSIC ADJUST** only when **MUSIC** has been selected.

4 Touch ▲ or ▼ to select PANORAMA (panorama).

Each time you touch ▲ or ▼ selects the item in the following order:

PANORAMA (panorama)—**DIMENSION** (dimension)—**CENTER WIDTH** (center width)

5 Touch ▶ to turn the panorama control on.

- To turn the panorama control off, touch ◀.

Available accessories

6 Touch ▼ to select DIMENSION and then touch ◀ or ▶ to adjust front/surround speaker balance.

Each time you touch ◀ or ▶ it moves the sound towards the front or the surrounds. +3 to -3 is displayed as the front/surround speaker balance moves from front to surrounds.

7 Touch ▼ to select CENTER WIDTH and then touch ◀ or ▶ to adjust the center image.

Each time you touch ◀ or ▶ it gradually spreads the center channel sound into the front left and right speakers over a range 0 to 7.

3 is the default and it's recommended for most recordings. 0 places all center sound in the center speaker. 7 places all center sound equally in the left/right speakers.

Setting the speaker setting

You need to make with/without (or yes/no) and size (bass reproducing capacity) selection/adjustments depending on the installed speakers. The size needs to be set to **LARGE** (large) if the speaker is capable of reproducing sounds of about 100 Hz or below. Otherwise select **SMALL** (small).

- Low frequency range is not output if the subwoofer is set to **OFF** and the front and rear speakers set to **SMALL** or **OFF**.
- It is imperative that non-installed speakers be set to **OFF**.
- Set the front or rear speaker to **LARGE** if the speaker is capable of reproducing bass content, or if no subwoofer is installed.

1 Touch NEXT on the DSP function menu.

2 Touch SPEAKER SETTING.

3 Touch ▲ or ▼ to select the speaker to be adjusted.

Each time you touch ▲ or ▼ selects the speaker in the following order:

FRONT (front speakers)—**CENTER** (center speaker)—**REAR** (rear speakers)—

SUB WOOFER (subwoofer)—**PHASE** (subwoofer setting)

- You can switch to **PHASE** only when the subwoofer has been set to **ON**.

4 Touch ◀ or ▶ to select the correct size for the selected speaker.

Each time you touch ◀ or ▶ selects the size in the following order:

OFF (off)—**SMALL** (small)—**LARGE** (large)

- You cannot select **OFF**, when **FRONT** (front speakers) have been selected.
- You can select **ON** or **OFF**, when **SUB WOOFER** (subwoofer) has been selected.
- You can switch **REVERSE** (reverse phase) or **NORMAL** (normal phase), when **PHASE** (subwoofer setting) has been selected.

Correcting the subwoofer's phase

If trying to boost the bass output of the subwoofer doesn't do much or rather makes you feel that the bass gets more murky, this may indicate that the subwoofer's output and bass content you hear over other speakers cancel each other out. To remove this problem, try changing the phase setting for the subwoofer.

1 Touch NEXT on the DSP function menu.

2 Touch SPEAKER SETTING.

3 Touch ▲ or ▼ to select SUB WOOFER (subwoofer).

Each time you touch ▲ or ▼ selects the speaker in the following order:

Available accessories

FRONT (front speakers)—**CENTER** (center speaker)—**REAR** (rear speakers)—**SUB WOOFER** (subwoofer)—**PHASE** (subwoofer setting)

4 Touch ► to turn subwoofer output on.

- To turn subwoofer output off, touch ◀.

5 Touch ▼ and then touch ◀ or ► to select the phase of subwoofer output.

Touch ► to select normal phase and **NORMAL** appears in the display. Touch ◀ to select reverse phase and **REVERSE** appears in the display.



Note

When playing a 2-channel mono source with Pro Logic turned on, there may be occasions when the following will occur:

- No audio is outputted if the center speaker setting is **SMALL** or **LARGE** and no center speaker is installed.
- Audio is heard only over the center speaker if installed and the center speaker setting is **SMALL** or **LARGE**.

Adjusting the speaker output levels

Speaker level can be adjusted finely by listening to an audio output. First, use test tone to adjust the approximate speaker level, and then use this function to adjust finely.

1 Touch NEXT on the DSP function menu.

2 Touch SPEAKER LEVEL.

3 Touch ▲ or ▼ to select the speaker to be adjusted.

Each time you touch ▲ or ▼ selects the speaker in the following order:

FRONT L (front speaker left)—**CENTER** (center speaker)—**FRONT R** (front speaker right)—**REAR R** (rear speaker right)—**REAR L** (rear speaker left)—**SUB WOOFER** (subwoofer)

- You cannot select speakers whose size is set at **OFF**. (Refer to *Setting the speaker setting* on the previous page.)

4 Touch ◀ or ► to adjust the speaker output level.

Each time you touch ◀ or ► increases or decreases the speaker output level. **+10** to **-10** is displayed as the level is increased or decreased.



Note

To adjust the speaker output levels in this mode is the same as making the speaker output levels at **TEST TONE**. Both provide the same results.

Selecting a cross-over frequency

You can select a frequency, under which sounds are reproduced through the subwoofer. If the installed speakers include one whose size has been set to **SMALL**, you can select a frequency, under which sounds are reproduced through a **LARGE** speaker or subwoofer.

1 Touch NEXT on the DSP function menu.

2 Touch CROSS OVER.

3 Touch ▲ or ▼ to select the speaker to be adjusted.

Each time you touch ▲ or ▼ selects the speaker in the following order:

FRONT (front speakers)—**CENTER** (center speaker)—**REAR** (rear speakers)—**SUB WOOFER** (subwoofer)

Available accessories

4 Touch ◀ or ▶ to select cross-over frequency.

Each time you touch ◀ or ▶ selects cross-over frequencies in the following order:

63—80—100—125—160—200 (Hz)



Note

Selecting a cross-over frequency is to set a cross-over frequency of the subwoofer's L.P.F. (low-pass filter) and that of the **SMALL** speaker H.P.F. (high-pass filter). The cross-over frequency setting has no effect if the subwoofer is set to **OFF** and other speakers are set to **LARGE** or **OFF**.

Adjusting the speaker output levels using a test tone

This function allows you to easily get the overall balance right among the speakers.

1 Touch NEXT on the DSP function menu.

2 Touch TEST TONE.

3 Touch START to start the test tone output.

The test tone is outputted. It rotates from speaker to speaker in the following sequence at intervals of about two seconds. The current settings for the speaker over which you hear the test tone are shown in the display.

FRONT L (front speaker left)—**CENTER** (center speaker)—**FRONT R** (front speaker right)—**REAR R** (rear speaker right)—**REAR L** (rear speaker left)—**SUB WOOFER** (subwoofer)

Check each speaker output level. If no adjustments are needed, perform step 5 to stop the test tone.

- The settings do not appear for speakers whose size is set **OFF**. (Refer to *Setting the speaker setting* on page 79.)

4 Touch ◀ or ▶ to adjust the speaker output level.

Each time you touch ◀ or ▶ increases or decreases the speaker output level. **+10** to **-10** is displayed as the level is increased or decreased.

- The test tone rotates to the next speaker after about two seconds from the last operation.

5 Touch STOP to stop the test tone output.



Notes

- If needed, select speakers and adjust their 'absolute' output levels. (Refer to *Adjusting the speaker output levels* on the previous page.)
- To adjust the speaker output levels in this mode is the same as making the speaker output levels at **SPEAKER LEVEL**. Both provide the same results.

Using the time alignment

The time alignment lets you adjust the distance between each speaker and the listening position.

1 Touch NEXT on the DSP function menu.

2 Touch TIME ALIGNMENT.

3 Touch any of the following touch panel keys to select the time alignment.

- **INITIAL** – Initial time alignment (factory setting)
- **AUTO TA** – Time alignment created by auto TA and EQ. (Refer to *Auto TA and EQ (auto-time alignment and auto-equalizing)* on page 84.)
- **CUSTOM** – Adjusted time alignment that you can create for yourself
- **OFF** – Turn the time alignment off

- **ADJUSTMENT** – Adjust the time alignment as desired
 - You cannot select **AUTO TA** if auto TA and EQ has not been carried out.
 - You cannot select **ADJUSTMENT** when neither **FRONT-L** nor **FRONT-R** is selected in **POSITION**.

Adjusting the time alignment

You can adjust the distance between each speaker and the selected position.

- An adjusted time alignment is memorized in **CUSTOM**.

1 Touch **NEXT** on the **DSP** function menu.

2 Touch **TIME ALIGNMENT** and then touch **ADJUSTMENT**.

- You cannot select **ADJUSTMENT** when neither **FRONT-L** nor **FRONT-R** is selected in **POSITION**.

3 Touch **▲** or **▼** to select the speaker to be adjusted.

Each time you touch **▲** or **▼** selects the speaker in the following order:

FRONT L (front speaker left)—**CENTER** (center speaker)—**FRONT R** (front speaker right)—**REAR R** (rear speaker right)—**REAR L** (rear speaker left)—**SUB WOOFER** (subwoofer)

- You cannot select speakers whose size is set at **OFF**. (Refer to *Setting the speaker setting* on page 79.)

4 Touch **◀** or **▶** to adjust the distance between the selected speaker and the listening position.

Each time you touch **◀** or **▶** increases or decreases the distance. **0.0cm** to **500.0cm** is displayed as the distance is increased or decreased.

Using the equalizer

The equalizer lets you adjust the equalization to match car interior acoustic characteristics as desired.

Recalling equalizer curves

There are seven stored equalizer curves which you can easily recall at any time. Here is a list of the equalizer curves:

Display	Equalizer curve
POWERFUL	Powerful
NATURAL	Natural
VOCAL	Vocal
FLAT	Flat
CUSTOM1	Custom 1
CUSTOM2	Custom 2
SUPER BASS	Super bass

- **CUSTOM1** and **CUSTOM2** are adjusted equalizer curves.
- When **FLAT** is selected no supplement or correction is made to the sound. This is useful to check the effect of the equalizer curves by switching alternatively between **FLAT** and a set equalizer curve.

● On the normal display, touch **EQ** to select the equalizer.

Touch **EQ** repeatedly to switch between the following equalizers:

POWERFUL—**NATURAL**—**VOCAL**—**FLAT**—**CUSTOM1**—**CUSTOM2**—**SUPER BASS**

- If **SFC** instead of **EQ** appears on the normal display, touch **SFC** and hold to switch to equalizer function. About **SFC**, refer to *Using the sound field control* on page 75.

Available accessories

Adjusting 3-band parametric equalizer

For **CUSTOM1** and **CUSTOM2** equalizer curves, you can adjust the front, rear and center equalizer curves separately by selecting a center frequency, an equalizer level and a Q factor for each band.

- A separate **CUSTOM1** curve can be created for each source.
- A **CUSTOM2** curve can be created common to all sources.
- The center speaker largely determines the sound image and getting the balance right isn't easy. We recommend reproducing a 2-ch. audio (a CD for example) and getting the balance right among the speakers except for the center, and then reproducing a 5.1-ch. audio (Dolby Digital or DTS) and adjusting the center speaker output to the balance you have already got among the other speakers.

1 Touch NEXT twice on the DSP function menu.

2 Touch PARAMETRIC EQ.

3 Touch ▲ or ▼ to select the desired item.

Each time you touch ▲ or ▼ selects the item in the following order:

EQ (equalizer)—**SP-SELECT** (speakers)—**BAND** (bands)—**FREQUENCY** (center frequency)—**LEVEL** (equalizer level)—**Q. FACTOR** (Q factor)

4 Touch ► to select the equalizer.

Touch ► repeatedly to switch between the following equalizers:

POWERFUL—NATURAL—VOCAL—FLAT—CUSTOM1—CUSTOM2—SUPER BASS

5 Touch ▼ and then touch ◀ or ▶ to select the speaker to be adjusted.

Touch ◀ or ▶ until the desired speaker appears in the display.

REAR (rear speakers)—**CENTER** (center speaker)—**FRONT** (front speakers)

- You cannot select speakers whose size is set at **OFF**. (Refer to *Setting the speaker setting* on page 79.)

6 Touch ▼ and then touch ◀ or ▶ to select the equalizer band to be adjusted.

Each time you touch ◀ or ▶ selects equalizer bands in the following order:

LOW (low)—**MID** (mid)—**HIGH** (high)

7 Touch ▼ and then touch ◀ or ▶ to select the center frequency of selected band.

Touch ◀ or ▶ until the desired frequency appears in the display.

40Hz—50Hz—63Hz—80Hz—100Hz—125Hz—160Hz—200Hz—250Hz—315Hz—400Hz—500Hz—630Hz—800Hz—1kHz—1.25kHz—1.6kHz—2kHz—2.5kHz—3.15kHz—4kHz—5kHz—6.3kHz—8kHz—10kHz—12.5kHz

8 Touch ▼ and then touch ◀ or ▶ to adjust the equalizer level.

Each time you touch ◀ or ▶ it increases or decreases the equalizer level. **+12** to **-12** is displayed as the level is increased or decreased.

9 Touch ▼ and then touch ◀ or ▶ to select the desired Q factor.

Each time you touch ◀ or ▶ switches between the following Q factor:

NARROW (narrow)—**WIDE** (wide)

- You can adjust parameters for each band of the other speakers in the same way.



Note

You can select a center frequency for each band. You can change the center frequency in 1/3-octave steps, but you cannot select frequencies that have intervals shorter than 1 octave among the center frequencies of the three bands.

Using the auto-equalizer

The auto-equalizer is the equalizer curve created by auto TA and EQ (refer to *Auto TA and EQ (auto-time alignment and auto-equalizing)* on this page).

You can turn the auto-equalizer on or off.

1 Touch NEXT twice on the DSP function menu.

2 Touch AUTO EQ.

- You cannot use this function if auto TA and EQ has not been carried out.

3 Touch ► to turn the auto-equalizer on.

- To turn auto-equalizer off, touch ◀.

Auto TA and EQ (auto-time alignment and auto-equalizing)

The auto-time alignment is automatically adjusted for the distance between each speaker and the listening position.

The auto-equalizer automatically measures the car interior acoustic characteristics, and then creates the auto-equalizer curve based on that information.

WARNING

To prevent accidents, never carry out auto TA and EQ while driving. When this function measures the car interior acoustic characteristics to create an auto-equalizer curve, a loud measurement tone (noise) may be outputted from the speakers.

CAUTION

- Carrying out auto TA and EQ under the following conditions may damage the speakers. Be sure to check the conditions thoroughly before carrying out auto TA and EQ.

- When speakers are incorrectly connected. (e.g., When a rear speaker is connected to a subwoofer output.)
- When a speaker is connected to a power amp delivering output higher than the speaker's maximum input power capability.
- If the microphone is placed in an unsuitable position the measurement tone may become loud and measurement may take a long time, resulting in a drain on battery power. Be sure to place the microphone in the specified location.

Before operating the auto TA and EQ function

- Carry out auto TA and EQ in as quiet a place as possible, with the car engine and air conditioning switched off. Also cut power to car phones or portable telephones in the car, or remove them from the car before carrying out auto TA and EQ. Sounds other than the measurement tone (surrounding sounds, engine sound, telephones ringing etc.) may prevent correct measurement of the car interior acoustic characteristics.
- Be sure to carry out auto TA and EQ using the supplied microphone. Using another microphone may prevent measurement, or result in incorrect measurement of the car interior acoustic characteristics.
- When front speaker is not connected, auto TA and EQ cannot be carried out.
- When this unit is connected to a power amp with input level control, auto TA and EQ may not be possible if you lower power amp input level. Set the power amp's input level to the standard position.

Available accessories

- When this unit is connected to a power amp with an LPF, turn off the LPF on the power amp before carrying out auto TA and EQ. In addition, the cut-off frequency for built-in LPF of an active subwoofer should be set to the highest frequency.
- The time alignment value calculated by auto TA and EQ may differ from the actual distance in the following circumstances. However, the distance has been calculated by computer to be the optimum delay to give accurate results for the circumstances, so please continue to use this value.
 - When the reflected sound within a vehicle is strong and delays occur.
 - When delays occur for low sounds due to the influence of the LPF on active subwoofers or external amps.
- Auto TA and EQ changes the audio settings as below:
 - The fader/balance settings return to the center position. (Refer to page 76.)
 - The equalizer curve switches to **FLAT**. (Refer to page 82.)
 - It will be adjusted automatically to high pass filter setting for front, center and rear speaker.
- If you carry out auto TA and EQ when a previous setting of this already exists, the setting will be replaced.

Carrying out auto TA and EQ

1 Stop the car in a place that is as quiet as possible, close all doors, windows and the sun roof, and then turn the engine off.

If the engine is left running, engine noise may prevent correct auto TA and EQ.

2 Fix the supplied microphone in the center of the headrest of the driver's seat, facing forward, using the belt (sold separately).

The auto TA and EQ may differ depending on where you place the microphone. If desired, place the microphone on the front passenger seat to carry out auto TA and EQ.

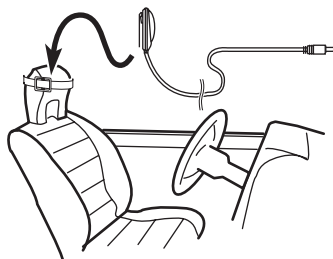

3 Turn the ignition switch to ON or ACC.

If the car's air conditioner or heater is turned on, turn it off. Noise from the fan in the air conditioner or heater may prevent correct auto TA and EQ.

- Press **SOURCE** to turn the source on if this unit is turned off.

4 Select the position for the seat on which the microphone is placed.

Refer to *Using the position selector* on page 76.

- If no position is selected before you start auto TA and EQ, **FRONT-L** is selected automatically.

5 Press SOURCE and hold until the unit turns off.

6 Touch the screen to display the touch panel keys.

7 Touch and hold EQ to enter the auto TA and EQ measurement mode.

8 Plug the microphone into the microphone input jack on the multi-channel processor.

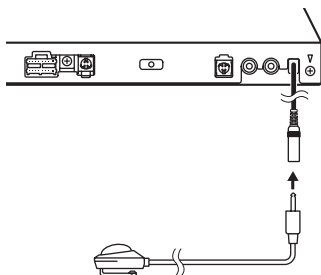

For details concerning operation, refer to the multi-channel processor's operation manual.

9 Touch START to start the auto TA and EQ.

10 Get out of the car and close the door within 10 seconds when the 10-second count-down starts.

The measurement tone (noise) is outputted from the speakers, and auto TA and EQ begins.

- When all speakers are connected, auto TA and EQ is completed in about nine minutes.
- To stop auto TA and EQ, touch **STOP**.
- To cancel auto TA and EQ part way through, touch **BACK** or **ESC**.

11 When auto TA and EQ is completed, Complete is displayed.

When correct measurement of car interior acoustic characteristics is not possible, an error message is displayed. (Refer to *Understanding auto TA and EQ error messages* on page 90.)

12 Touch ESC to cancel the auto TA and EQ mode.

13 Store the microphone carefully in the glove compartment.

Store the microphone carefully in the glove compartment or any other safe place. If the microphone is subjected to direct sunlight for an extended period, high temperatures may cause distortion, color change or malfunction. ■

Additional Information

Troubleshooting

Common

Symptom	Cause	Action (See)
Power doesn't turn on. The unit doesn't operate.	Leads and connectors are incorrectly connected.	Confirm once more that all connections are correct.
	The fuse is blown.	Rectify the reason for the fuse blowing, then replace the fuse. Be very sure to install the correct fuse with the same rating.
	Noise and other factors are causing the built-in microprocessor to operate incorrectly.	Press RESET . (Page 12)
Operation with the remote control isn't possible. The unit does not operate correctly even when the appropriate remote control buttons are pressed.	The remote control operation mode is incorrect.	Switch to the correct remote control mode. (Page 19)
	The remote control code is incorrect.	Make sure the remote control selection switch setting and code type setting are the same. (Page 46)
	Battery power is low.	Load new battery. (Page 13)
	Some operations are prohibited with certain discs.	Check by using another disc.
Playback is not possible.	The disc is dirty.	Clean disc. (Page 92)
	The loaded disc is a type this unit cannot play.	Check what type the disc is.
	Non compatible video system disc is loaded.	Change to a disc compatible to your video system.
No sounds are heard. The volume level will not rise.	Cables are not connected correctly.	Connect the cables correctly.
	The unit is performing still, slow motion or frame-by-frame playback.	There is no sound during still, slow motion or frame-by-frame playback.
There is no picture.	The parking brake cord is not connected.	Connect a parking brake cord, and apply the parking brake.
	The parking brake is not applied.	Connect a parking brake cord, and apply the parking brake.
The icon  is displayed, and operation is not possible.	The operation is prohibited for the disc.	This operation is not possible.
	The operation is not compatible with the disc's organization.	This operation is not possible.
The picture stops (pauses) and the unit cannot be operated.	Reading of data has become impossible during playback.	After stopping playback once, start playback once more.
There is no sound. Volume level is low.	The volume level is low.	Adjust the volume level.
	The attenuator is on.	Turn the attenuator off.
There is audio and video skipping.	The unit is not firmly secured.	Secure the unit firmly.
The picture is stretched, the aspect is incorrect.	The aspect setting is incorrect for the display.	Select the appropriate setting for your display. (Page 43)

Additional Information

Symptom	Cause	Action (See)
When the ignition switch is turned ON (or turned to ACC), the motor sounds.	The unit is confirming whether a disc is loaded or not.	This is a normal operation.
Nothing is displayed. The touch panel keys cannot be used.	The rear view camera is not connected. CAMERA POLARITY is at incorrect setting.	Connect a rear view camera. Press and hold DISPLAY to return to the source display and then select the correct setting for CAMERA POLARITY . (Page 53)

Problems during DVD playback

Symptom	Cause	Action (See)
Playback is not possible.	The loaded disc has a different region number from this unit.	Replace the disc with one featuring the same region number as this unit. (Page 8, Page 100)
A parental lock message is displayed and playback is not possible.	Parental lock is on.	Turn parental lock off or change the level. (Page 44)
Parental lock cannot be canceled.	The code number is incorrect.	Input the correct code number. (Page 44)
	You have forgotten your code number.	Touch C 10 times to cancel the code number. (Page 45)
Dialog language (and subtitle language) cannot be switched.	The DVD playing does not feature multiple language recordings.	You cannot switch among multiple languages if they are not recorded on the disc.
	You can only switch between items indicated in the disc menu.	Switch using the disc menu.
No subtitles are displayed.	The DVD playing does not feature subtitles.	Subtitles are not displayed if they are not recorded on the disc.
	You can only switch between items indicated in the disc menu.	Switch using the disc menu.
Playback is not with the audio language and subtitle language settings selected in DVD SETUP .	The DVD playing does not feature dialog or subtitles in the language selected in DVD SETUP .	Switching to a selected language is not possible if the language selected in DVD SETUP is not recorded on the disc.
Switching the viewing angle is not possible.	The DVD playing does not feature scenes shot from multiple angles.	You cannot switch between multiple angles if the DVD does not feature scenes recorded from multiple angles.
	You are trying to switch to multiple angle viewing of a scene that is not recorded from multiple angles.	Switch between multiple angles when watching scenes recorded from multiple angles.
The picture is extremely unclear/distorted and dark during playback.	The disc features a signal to prohibit copying. (Some discs may have this.)	Since this unit is compatible with the copy guard analog copy protect system, when playing a disc that has a signal prohibiting copying, the picture may suffer from horizontal stripes or other imperfections when viewed on some displays. This does not mean this unit is malfunctioning.

Additional Information

Problems during Video CD playback

Symptom	Cause	Action
The PBC (playback control) menu display cannot be called up.	The Video CD playing does not feature PBC.	This operation is not possible with Video CDs not featuring PBC.
Repeat play and track/time search are not possible.	The Video CD playing features PBC.	This operation is not possible with Video CDs featuring PBC.

Problems during iPod playback

Symptom	Cause	Action
iPod doesn't operate correctly.	Cables are incorrectly connected.	Disconnect the cable from iPod. Once iPod main menu is displayed, connect the cable again. Reset the iPod.
	The iPod version is old.	Update the iPod version.

Problems during multi-channel processor connection

Symptom	Cause	Action (See)
No sounds are heard. The volume level will not rise.	Optical cables are not connected correctly.	Connect the cables correctly.
Even if multi-channel audio is selected, 2-channel audio is output.	Digital output setting is set to Linear PCM .	Normally, set the digital output setting to STREAM . (Page 45)



Error messages

When you contact your dealer or your nearest Pioneer Service Center, be sure to record the error message.

Built-in DVD player

Message	Cause	Action
DIFFERENT REGION DISC (R ERROR)	The disc does not have the same region number as this unit	Replace the DVD video with one bearing the correct region number.
ERROR-02-XX	Dirty disc	Clean disc.
	Scratched disc	Replace disc.
	The disc is loaded upside down	Check that the disc is loaded correctly.
	Electrical or mechanical	Press RESET .

Additional Information

Message	Cause	Action
NON-PLAYABLE DISC (NON-PLAY)	This type of disc cannot be played by this unit	Replace the disc with one this unit can play.
	The inserted disc does not contain any files that can be played back	Replace disc.
PROTECT	All the files on the inserted disc are secured by DRM	Replace disc.
SKIPPED	The inserted disc contains WMA files that are protected by DRM	Replace disc.
TEMP	The temperature of this unit is outside the normal operating range	Wait until the unit's temperature returns to within normal operating limits.

iPod

Message	Cause	Action
ERROR-11	Communication failure	Disconnect the cable from iPod. Once iPod main menu is displayed, connect the cable again. Reset the iPod.
ERROR-21	Old version of iPod	Update the iPod version.
ERROR-30	iPod failure	Reset the iPod.
No Songs	No songs	Transfer the songs to iPod.
STOP	No songs in the current list	Select a list that contains the songs.
	iPod is not charged but operates correctly	Check if the connection cable for iPod shorted out (e.g., not caught in metal objects). After checking, switch the ignition key or disconnect the iPod and connect again.



Understanding auto TA and EQ error messages

When correct measurement of car interior acoustic characteristics is not possible using the auto TA and EQ, an error message may appear on the display. If an error message appears, refer to the table below to see what the problem is and the suggested method of correcting the problem. After checking, try again.

Message	Cause	Action
Error. Please check MIC.	Microphone is not connected.	Plug the supplied microphone securely into the jack.

Additional Information

Message	Cause	Action
Error. Please check front SP. Error. Please check FL SP. Error. Please check FR SP. Error. Please check center SP. Error. Please check rear SP. Error. Please check RL SP. Error. Please check RR SP. Error. Please check subwoofer	The microphone cannot pick up the measuring tone of a speaker.	<ul style="list-style-type: none"> • Confirm that the speakers are connected correctly. • Correct the input level setting of the power amp connected to the speakers. • Set the microphone correctly.
Error. Please check noise.	The surrounding noise level is too high.	<ul style="list-style-type: none"> • Stop your car in a place that is as quiet as possible, and switch off the engine, air conditioner or heater. • Set the microphone correctly.



Additional Information

Handling guideline of discs and player

- Use only conventional, fully circular discs. Do not use shaped discs.

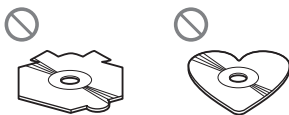

- Use 12-cm or 8-cm disc. Do not use an adapter when playing 8-cm discs.
- Do not insert anything other than a disc into the disc loading slot. Discs which can be played back are listed on *Playable discs* on page 8.
- Do not use cracked, chipped, warped, or otherwise damaged discs as they may damage the player.
- Do not touch the recorded surface of the discs.
- Store discs in their cases when not in use.
- Avoid leaving discs in excessively hot environments including under direct sunlight.
- Do not attach labels, write on or apply chemicals to the surface of the discs.
- To clean a disc, wipe the disc with a soft cloth outward from the center.
- Condensation may temporarily impair the player's performance. Leave it to adjust to the warmer temperature for about one hour. Also, wipe any dump discs with a soft cloth.
- Playback of discs may not be possible because of disc characteristics, disc format, recorded application, playback environment, storage conditions and so on.
- Road shocks may interrupt disc playback.
- Read the precautions with discs before using them.

DVD discs

- With some DVD video discs, it may not be possible to use certain functions.
- It may not be possible to play back some DVD video discs.
- It is not possible to play back DVD-ROM/ DVD-RAM discs.

DVD-R/DVD-RW discs

- Unfinalized DVD-R/-RW discs which have been recorded with the Video format (video mode) cannot be played back.
- DVD-R/-RW discs which have been recorded with the Video Recording format (VR mode) can be played back. However, unfinalized disc may not be played back. Unplayable disc should be finalized. In addition, finalized DVD-R DL (Dual Layer) disc cannot be recorded/edited.
- DVD-R DL (Dual Layer) discs which have been recorded with the Video Recording format (VR mode) can be played back. However, this unit is not compatible with Layer Jump recording mode.
- For more information about recording mode, please contact manufacture of DVD recorder or application.
- The following logo indicates that this unit is compatible with DVD-RW discs which have been recorded with the Video Recording format (VR mode).

RW
COMPATIBLE





Additional Information

AVCHD recorded discs

- This unit is not compatible with discs recorded in AVCHD (Advanced Video Codec High Definition) format. Do not insert AVCHD discs. If inserted, the disc may not be ejected. 

CD-R/CD-RW discs

- When CD-R/CD-RW discs are used, playback is possible only for discs which have been finalized.
 - It may not be possible to play back CD-R/CD-RW discs recorded on a music CD recorder or a personal computer because of disc characteristics, scratches or dirt on the disc, or dirt, condensation, etc., on the lens of this unit.
 - Playback of discs recorded on a personal computer may not be possible, depending on the application settings and the environment. Please record with the correct format. (For details, contact the manufacturer of the application.)
 - Playback of CD-R/CD-RW discs may become impossible in case of direct exposure to sunlight, high temperatures, or the storage conditions in the vehicle.
 - Titles and other text information recorded on a CD-R/CD-RW disc may not be displayed by this unit (in the case of audio data (CD-DA)).
 - Read the precautions with CD-R/CD-RW discs before using them. 
- Playback of the DVD side is possible with this unit. However, since the CD side of Dual Discs is not physically compatible with the general CD standard, it may not be possible to play the CD side with this unit.
 - Frequent loading and ejecting of a Dual Disc may result in scratches on the disc. Serious scratches can lead to playback problems on this unit. In some cases, a Dual Disc may become stuck in the disc loading slot and will not eject. To prevent this, we recommend you refrain from using Dual Disc with this unit.
 - Please refer to the information from the disc manufacturer for more detailed information about Dual Discs. 

Dual Discs

- Dual Discs are two-sided discs that have a recordable CD for audio on one side and a recordable DVD for video on the other.

Compressed audio files on the disc

- Depending on the version of Windows Media Player used to encode WMA files, album names and other text information may not be correctly displayed.
- There may be a slight delay when starting playback of audio files encoded with image data.
- ISO 9660 Level 1 and 2 compliant. Romeo and Joliet file systems are both compatible with this player.
- Multi-session playback is possible.
- Compressed audio files are not compatible with packet write data transfer.
- Only 64 characters from the beginning can be displayed as a file name (including the extension such as .wma or .mp3) or a folder name.
- Folder selection sequence or other operation may be altered depending on the encoding or writing software.

Additional Information

- Regardless of the length of blank section between the songs of original recording, compressed audio discs will play with a short pause between songs.
- File extensions such as .wma, .mp3 or .m4a must be used properly.

Example of a hierarchy

📁: Folder

🎵: Compressed audio file

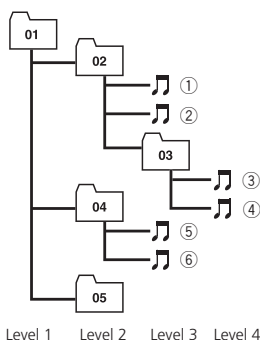

- This unit assigns folder numbers. The user cannot assign folder numbers.
- It is possible to play back up to 255 folders on one disc.

Compressed audio compatibility

WMA

- Compatible format: WMA encoded by Windows Media Player Ver. 7, 7.1, 8, 9 or 10
- Bit rate: 5 kbps to 320 kbps (CBR), VBR
- Sampling frequency: 8 kHz to 48 kHz
- Windows Media Audio 9 Professional, Lossless, Voice: No

MP3

- Bit rate: 8 kbps to 320 kbps (CBR), VBR
- Sampling frequency: 8 kHz to 48 kHz (emphasis: 8 kHz to 48 kHz)

- Compatible ID3 tag version: 1.0, 1.1, 2.2, 2.3 (ID3 tag Version 2.x is given priority than Version 1.x.)
- M3u playlist: No
- MP3i (MP3 interactive), mp3 PRO: No

AAC

- Compatible format: AAC encoded by iTunes® version 6.0.5 and earlier
- Bit rate: 8 kbps to 320 kbps (CBR)
- VBR: No
- Sampling frequency: 8 kHz to 44.1 kHz
- Apple Lossless: No

DivX video files

- Depending on the file information composition such as the number of audio stream, there may be a slight delay in the start of playback on discs.
- Some special operation may be prohibited because of the composition of DivX files.
- DivX files downloaded only from DivX partner site are guarantee of proper operation. Unauthorized DivX file may not operate properly.
- DRM rental file cannot be operated until starting playing back.
- This unit corresponds to a DivX file display up to 1 590 minutes 43 seconds. Also, search operation beyond this time limit is prohibited.
- If a file contains more than 4 GB, playback is stopped on the way.
- DivX VOD file playback requires ID code of this unit to DivX VOD provider. About ID code, refer to *Displaying your DivX® VOD registration code* on page 45.
- File extensions such as .avi or .divx must be used properly.
- For more details about DivX, visit the following site:
<http://www.divx.com/>

Additional Information

DivX compatibility

- Compatible format: DivX video format implemented in relation to DivX standards
- DivX Ultra format: No
- DivX files without video data: No
- Compatible audio codec: MP2, MP3, Dolby Digital
- LPCM: No
- Bit rate: 8 kbps to 320 kbps (CBR), VBR
- Sampling frequency: 8 kHz to 48 kHz
- Compatible external subtitle file extension: .srt 

About handling the iPod

CAUTION

- Pioneer accepts no responsibility for data lost on the iPod even if that data is lost while using this unit.
- Do not leave the iPod in direct sunlight for extended amounts of time. Extended exposure to direct sunlight can result in iPod malfunction due to the resulting high temperature.
- Do not leave the iPod in any location with a high temperature.
- Firmly secure the iPod when driving. Do not let the iPod fall onto the floor, where it may become jammed under the brake or accelerator pedal.

For details, refer to the iPod's manuals.

About iPod settings

- You cannot operate the iPod Equalizer on the Pioneer products. We recommend that you set the iPod Equalizer to off, before connecting the iPod to this unit.
- You cannot set Repeat to off on the iPod when using this unit. Even if you set Repeat to off on the iPod, Repeat is changed to All

automatically when connecting the iPod to this unit. 

Using the display correctly

CAUTION

- If liquid or foreign matter should get inside this unit, turn off the power immediately and consult your dealer or the nearest authorized PIONEER Service Station. Do not use the unit in this condition because doing so may result in a fire, electric shock, or other failure.
- If you notice smoke, a strange noise or smell, or any other abnormal signs from the display, turn off the power immediately and consult your dealer or the nearest authorized PIONEER Service Station. Using this unit in this condition may result in permanent damage to the system.
- Do not disassemble or modify this unit, as there are high-voltage components inside which may cause an electric shock. Be sure to consult your dealer or the nearest authorized PIONEER Service Station for internal inspection, adjustments or repairs.

Handling the display

- When the display is subjected to direct sunlight for a long period of time, it will become very hot resulting in possible damage to the LCD screen. When not using this unit, close the display and avoid exposing it to direct sunlight.
- The display should be used within the temperature ranges shown below.
Storage temperature range: -20 °C to +80 °C
At temperatures higher or lower than the operating temperature range the display may not operate normally.

Additional Information

- The LCD screen of this unit is exposed in order to increase its visibility within the vehicle. Please do not press strongly on it as this may damage it.
- Do not place anything on the display when it is opened. Also, do not attempt to carry out angle adjustment, or open/close the display by hand. Applying strong force to the display may damage it.
- Do not push the LCD screen with much force as this may scratch it.
- Be careful not to place anything between the display and the main body when the display is opening or closing. If an object gets between the display and main body, the display may stop working.
- Be careful of fingers, long hair, and loose articles of clothing which could possibly get caught between the display and the main body and cause serious injury.

Liquid crystal display (LCD) screen

- If the display is near the vent of an air conditioner when it is opened, make sure that air from the air conditioner is not blowing on it. Heat from the heater may damage the LCD screen, and cool air from the cooler may cause moisture to form inside the display resulting in possible damage. Also, if the display is cooled down by the cooler, the screen may become dark, or the life span of the small fluorescent tube used inside the display may be shortened.
- Small black dots or white dots (bright dots) may appear on the LCD screen. These are due to the characteristics of the LCD screen and do not indicate a problem with the display.
- At low temperatures, the LCD screen may be dark for a while after the power is turned on.
- The LCD screen will be difficult to see if it is exposed to direct sunlight.

- When using a portable phone, keep the antenna of the portable phone away from the display to prevent disruption of the video by the appearance of spots, colored stripes, etc.

Keeping the display in good condition

- When removing dust from the screen or cleaning the display, first turn the system power off, then wipe with a soft dry cloth.
- When wiping the screen, take care not to scratch the surface. Do not use harsh or abrasive chemical cleaners.

Small fluorescent tube

- A small fluorescent tube is used inside the display to illuminate the LCD screen.
 - The fluorescent tube should last for approximately 10 000 hours, depending on operating conditions. (Using the display at low temperatures reduces the service life of the fluorescent tube.)
 - When the fluorescent tube reaches the end of its useful life, the screen will be dark and the image will no longer be projected. If this happens, consult your dealer or the nearest authorized PIONEER Service Station. 

Additional Information

Language code chart for DVD

Language (code), input code	Language (code), input code	Language (code), input code
Japanese (ja), 1001	Guarani (gn), 0714	Pashto, Pushto (ps), 1619
English (en), 0514	Gujarati (gu), 0721	Quechua (qu), 1721
French (fr), 0618	Hausa (ha), 0801	Rhaeto-Romance (rm), 1813
Spanish (es), 0519	Hindi (hi), 0809	Kirundi (rn), 1814
German (de), 0405	Croatian (hr), 0818	Romanian (ro), 1815
Italian (it), 0920	Hungarian (hu), 0821	Kinyarwanda (rw), 1823
Chinese (zh), 2608	Armenian (hy), 0825	Sanskrit (sa), 1901
Dutch (nl), 1412	Interlingua (ia), 0901	Sindhi (sd), 1904
Portuguese (pt), 1620	Interlingue (ie), 0905	Sangho (sg), 1907
Swedish (sv), 1922	Inupiak (ik), 0911	Serbo-Croatian (sh), 1908
Russian (ru), 1821	Indonesian (in), 0914	Sinhalese (si), 1909
Korean (ko), 1115	Icelandic (is), 0919	Slovak (sk), 1911
Greek (el), 0512	Hebrew (iw), 0923	Slovenian (sl), 1912
Afar (aa), 0101	Yiddish (ji), 1009	Samoan (sm), 1913
Abkhazian (ab), 0102	Javanese (jw), 1023	Shona (sn), 1914
Afrikaans (af), 0106	Georgian (ka), 1101	Somali (so), 1915
Amharic (am), 0113	Kazakh (kk), 1111	Sambian (sq), 1917
Arabic (ar), 0118	Greenlandic (kl), 1112	Serbian (sr), 1918
Assamese (as), 0119	Cambodian (km), 1113	Siswati (ss), 1919
Aymara (ay), 0125	Kannada (kn), 1114	Sesotho (st), 1920
Azerbaijani (az), 0126	Kashmiri (ks), 1119	Sundanese (su), 1921
Bashkir (ba), 0201	Kurdish (ku), 1121	Swahili (sw), 1923
Byelorussian (be), 0205	Kirghiz (ky), 1125	Tamil (ta), 2001
Bulgarian (bg), 0207	Latin (la), 1201	Telugu (te), 2005
Bihari (bh), 0208	Lingala (ln), 1214	Tajik (tg), 2007
Bislama (bi), 0209	Laothian (lo), 1215	Thai (th), 2008
Bengali (bn), 0214	Lithuanian (lt), 1220	Tigrinya (ti), 2009
Tibetan (bo), 0215	Latvian (lv), 1222	Turkmen (tk), 2011
Breton (br), 0218	Malagasy (mg), 1307	Tagalog (tl), 2012
Catalan (ca), 0301	Maori (mi), 1309	Setswana (tn), 2014
Corsican (co), 0315	Macedonian (mk), 1311	Tonga (to), 2015
Czech (cs), 0319	Malayalam (ml), 1312	Turkish (tr), 2018
Welsh (cy), 0325	Mongolian (mn), 1314	Tsonga (ts), 2019
Danish (da), 0401	Moldavian (mo), 1315	Tatar (tt), 2020
Bhutani (dz), 0426	Marathi (mr), 1318	Twi (tw), 2023
Esperanto (eo), 0515	Malay (ms), 1319	Ukrainian (uk), 2111
Estonian (et), 0520	Maltese (mt), 1320	Urdu (ur), 2118
Basque (eu), 0521	Burmese (my), 1325	Uzbek (uz), 2126
Persian (fa), 0601	Nauru (na), 1401	Vietnamese (vi), 2209
Finnish (fi), 0609	Nepali (ne), 1405	Volapük (vo), 2215
Fiji (fj), 0610	Norwegian (no), 1415	Wolof (wo), 2315
Faroese (fo), 0615	Occitan (oc), 1503	Xhosa (xh), 2408
Frisian (fy), 0625	Oromo (om), 1513	Yoruba (yo), 2515
Irish (ga), 0701	Oriya (or), 1518	Zulu (zu), 2621
Scots-Gaelic (gd), 0704	Panjabi (pa), 1601	
Galician (gl), 0712	Polish (pl), 1612	



Additional Information

Terms

AAC

AAC is short for Advanced Audio Coding and refers to an audio compression technology standard used with MPEG 2 and MPEG 4.

Aspect ratio

This is the width-to-height ratio of a TV screen. A regular display has an aspect ratio of 4:3. Wide screen displays have an aspect ratio of 16:9, providing a bigger picture for exceptional presence and atmosphere.

Bit rate

This expresses data volume per second, or bps (bits per second) units. The higher the rate, the more information is available to reproduce the sound. Using the same encoding method (such as MP3), the higher the rate, the better the sound.

Chapter

DVD titles are in turn divided into chapters which are numbered in the same way as the chapters of a book. With DVD video discs featuring chapters, you can quickly find a desired scene with chapter search.

DivX

DivX is a popular media technology created by DivX, Inc. DivX media files contain highly compressed video with high visual quality that maintains a relatively small file size. DivX files can also include advanced media features like menus, subtitles, and alternate audio tracks. Many DivX media files are available for download online, and you can create your own using your personal content and easy-to-use tools from DivX.com.

DivX Certified

DivX Certified products are officially tested by the creators of DivX and guaranteed to play all versions of DivX video, including DivX 6.

Dolby Digital

Dolby Digital provides multi-channel audio from up to 5.1 independent channels. This is the same as the Dolby Digital surround sound system used in theaters.

Dolby Pro Logic II

Dolby Pro Logic II can create five full-bandwidth output channels from two-channel sources. This new technology enables a discrete 5-channel playback with 2 front channels, 1 center channel, and 2 rear channels. A music mode is also available for 2-channel sources in addition to the movie mode.

DTS

This stands for Digital Theater Systems. DTS is a surround system delivering multi-channel audio from up to 6 independent channels.

Dynamic range control

Dolby Digital has a function for compressing the difference between the loudest and softest sounds: Dynamic range control. This control ensures sounds with an increased dynamic range are heard clearly even at low volume levels.

ID3 tag

This is a method of embedding track-related information in an MP3 file. This embedded information can include the track title, the artist's name, the album title, the music genre, the year of production, comments and other data. The contents can be freely edited using software with ID3 Tag editing functions. Although the tags are restricted as to the number of characters, the information can be viewed when the track is played back.

ISO9660 format

This is the international standard for the format logic of CD-ROM folders and files. For the ISO9660 format, there are regulations for the following two levels.

Additional Information

Level 1:

The file name is in 8.3 format (the name consists of up to 8 characters, half-byte English capital letters and half-byte numerals and the “_” sign, with a file-extension of three characters).

Level 2:

The file name can have up to 31 characters (including the separation mark “.” and a file extension). Each folder contains less than 8 hierarchies.

Extended formats

Joliet:

File names can have up to 64 characters.

Romeo:

File names can have up to 128 characters.

Linear PCM (LPCM)/Pulse code modulation

This stands for linear pulse code modulation, which is the signal recording system used for music CDs and DVDs. Generally, DVDs are recorded with higher sampling frequency and bit rate than CDs. Therefore, DVDs can provide higher sound quality.

m3u

Playlists created using the “WINAMP” software have a playlist file extension (.m3u).

MP3

MP3 is short for MPEG Audio Layer 3. It is an audio compression standard set by a working group (MPEG) of the ISO (International Standards Organization). MP3 is able to compress audio data to about 1/10th the level of a conventional disc.

MPEG

This stands for Moving Pictures Experts Group, and is an international video image compression standard. Some DVDs feature digital audio compressed and recorded using this system.

Multi-angle

With regular TV programs, although multiple cameras are used to simultaneously shoot scenes, only images from one camera at a time are transmitted to your TV. Some DVDs feature scenes shot from multiple angles, letting you choose your viewing angle as desired.

Multi-audio (Multilingual dialog)

Some DVDs feature dialog recorded in multiple languages. Dialog in up to 8 languages can be recorded on a single disc, letting you choose as desired.

Multi-session

Multi-session is a recording method that allows additional data to be recorded later. When recording data on a CD-ROM, CD-R or CD-RW, etc., all data from beginning to end is treated as a single unit or session. Multi-session is a method of recording more than 2 sessions on one disc.

Multi-subtitle

Subtitles in up to 32 languages can be recorded on a single DVD, letting you choose as desired.

Optical digital output/input

By transmitting and receiving audio signals in a digital signal format, the chance of sonic quality deteriorating in the course of transmission is minimized. An optical digital output/input is designed to transmit and receive digital signals optically.

Packet write

This is a general term for a method of writing on CD-R, etc., at the time required for a file, just as is done with files on floppy or hard discs.

Additional Information

Parental lock

Some DVD video discs with violent or adult-oriented scenes feature parental lock which prevents children from viewing such scenes. With this kind of disc, if you set the unit's parental lock level, playback of scenes inappropriate for children will be disabled, or these scenes will be skipped.

Playback control (PBC)

This is a playback control signal recorded on Video CDs (Version 2.0). Using menu displays provided by Video CDs with PBC lets you enjoy playback of simple interactive software and software with search functions. You can also enjoy viewing high- and standard-resolution still images.

Region number

DVD players and DVD discs feature region numbers indicating the area in which they were purchased. Playback of a DVD is not possible unless it features the same region number as the DVD player. This unit's region number is displayed on the bottom of the unit.

Title

DVD video discs have high data capacity, enabling recording of multiple movies on a single disc. If, for example, one disc contains three separate movies, they are divided into title 1, title 2 and title 3. This lets you enjoy the convenience of title search and other functions.

VBR

VBR is short for variable bit rate. Generally speaking CBR (constant bit rate) is more widely used. But by flexibly adjusting the bit rate according to the needs of audio compression, it is possible to achieve compression-priority sound quality.

WMA

WMA is short for Windows Media™ Audio and refers to an audio compression technology that is developed by Microsoft Corporation. WMA data can be encoded by using Windows Media Player version 7 or later.

Windows Media and the Windows logo are trademarks or registered trademarks of Microsoft Corporation in the United States and/or other countries. □

Additional Information

Specifications

General

Rated power source	14.4 V DC (allowable voltage range: 12.0 V to 14.4 V DC)
Grounding system	Negative type
Max. current consumption	10.0 A
Dimensions (W × H × D):	
DIN	
Chassis	178 × 50 × 160 mm
Nose	188 × 58 × 33 mm
D	
Chassis	178 × 50 × 165 mm
Nose	170 × 46 × 28 mm
Weight	2.4 kg

Display

Screen size/aspect ratio	7.0 inch wide/16:9 (effective display area: 154 × 87 mm)
Pixels	336 960 (1 440 × 234)
Type	TFT active matrix, transmis- sive type
Color system	NTSC/PAL/PAL-M/SECAM compatible
Storage temperature range	-20 °C to +80 °C
Angle adjustment	50° to 110° (initial settings: 90°)

Audio

Maximum power output	50 W × 4 50 W × 2/4 Ω + 70 W × 1/2 Ω (for subwoofer)
Continuous power output	22 W × 4 (50 Hz to 15 000 Hz, 5% THD, 4 Ω load, both channels driven)
Load impedance	4 Ω to 8 Ω × 4 4 Ω to 8 Ω × 2 + 2 Ω × 1
Preout max output level/output impedance	4.0 V/100 Ω
Equalizer (7-Band Graphic Equalizer):	
Frequency	50/125/315/800/2k/5k/12.5k Hz
Gain	± 12 dB
Loudness contour:	
Low	+3.5 dB (100 Hz), +3 dB (10 kHz)

Mid	+10 dB (100 Hz), +6.5 dB (10 kHz)
High	+11 dB (100 Hz), +11 dB (10 kHz) (volume: -30 dB)
HPF:	
Frequency	50/63/80/100/125 Hz
Slope	-12 dB/oct
Subwoofer (mono):	
Frequency	50/63/80/100/125 Hz
Slope	-18 dB/oct
Gain	+6 dB to -24 dB
Phase	Normal/Reverse
Bass boost:	
Gain	+12 dB to 0 dB

DVD Player

System	DVD video, DVD-VR, Video CD, CD, WMA, MP3, AAC, DivX system
Usable discs	DVD video, Video CD, CD, CD-R/RW, DVD-R/RW
Region number:	
for Middle East Asian and South African models	2
for Southeast Asian models	3
for South American and Oceanian models	4
Signal format:	
Sampling frequency	44, 1/48/96 kHz
Number of quantization bits	16/20/24; linear
Frequency response	5 Hz to 44 000 Hz (with DVD, at sampling frequency 96 kHz)
Signal-to-noise ratio	97 dB (1 kHz) (IEC-A net- work) (CD: 96 dB (1 kHz) (IEC-A network))
Dynamic range	95 dB (1 kHz) (CD: 94 dB (1 kHz))
Distortion	0.008 % (1 kHz)
Output level:	
Video	1.0 Vp-p/75 Ω (±0.2 V)
Number of channels	2 (stereo)
MP3 decoding format	MPEG-1 & 2 Audio Layer 3
WMA decoding format	Ver. 7, 7.1, 8, 9, 10 (2ch audio) (Windows Media Player)
AAC decoding format	MPEG-4 AAC (iTunes® en- coded only)

Additional Information

DivX decoding format Home Theater Ver. 3, 4, 5.2
(.avi .divx)

FM tuner

Frequency range 87.5 MHz to 108.0 MHz
 Usable sensitivity 8 dBf ($0.7 \mu\text{V}/75 \Omega$, mono,
 S/N: 30 dB)
 Signal-to-noise ratio 75 dB (IEC-A network)
 Distortion 0.3 % (at 65 dBf, 1 kHz,
 stereo)
 0.1 % (at 65 dBf, 1 kHz,
 mono)
 Frequency response 30 Hz to 15 000 Hz (± 3 dB)
 Stereo separation 45 dB (at 65 dBf, 1 kHz)

AM tuner

Frequency range 531 kHz to 1 602 kHz (9 kHz)
 530 kHz to 1 640 kHz (10
 kHz)
 Usable sensitivity $18 \mu\text{V}$ (S/N: 20 dB)
 Signal-to-noise ratio 65 dB (IEC-A network)

Infrared remote control

Wavelength 945 nm
 Output typ; 10 mw/sr per Infrared
 LED



Note

Specifications and the design are subject to possible modifications without notice due to improvements. ■

- A**
- Angle icon 30, 43
 - Aspect ratio 43, 98
 - Audio language 30, 42
- B**
- Bookmark 29
 - Brightness 51
- C**
- Chapter 98
 - Code number 44
 - Color 51
 - Contrast 51
- D**
- DivX 98
 - DivX Certified 98
 - DTS 9, 98
 - Dynamic range control 98
- H**
- Hue 51
- L**
- Language code chart 97
 - Linear PCM (LPCM) 99
- M**
- Menu language 43
 - MPEG 99
 - Multi-angle 30, 99
 - Multi-audio 30, 99
 - Multi-subtitle 30, 99
- O**
- Optical digital output/input 99
- P**
- Parental lock 44, 100
 - PBC (playback control) 26
 - Playback control (PBC) 100
- R**
- Region number 8, 100
- S**
- Subtitle language 30, 42
- T**
- Title 100
 - TV aspect 43
- V**
- Video CD 8
- W**
- Wide screen mode 50

Visit us on the World Wide Web at



<Middle East & Africa>

Pioneer Gulf.FZE

www.pioneer-uae.com

<Oceania>

Pioneer Electronics Australia. Pty.Ltd

www.pioneeraus.com.au

<Asia>

Pioneer Electronics Asiacentre.Pte

www.pioneer.com.sg

Pioneer (HK) Ltd.

www.pioneerhongkong.com.hk

Pioneer High Fidelity Taiwan Co., Ltd.

www.pioneer-twn.com.tw

<Latin>

Pioneer International Latin America S.A.

www.pioneer-latin.com

PIONEER CORPORATION

4-1, MEGURO 1-CHOME, MEGURO-KU
TOKYO 153-8654, JAPAN

PIONEER ELECTRONICS (USA) INC.

P.O. Box 1540, Long Beach, California 90801-1540, U.S.A.
TEL: (800) 421-1404

PIONEER EUROPE NV

Haven 1087, Keetberglaan 1, B-9120 Melsele, Belgium
TEL: (0) 3/570.05.11

PIONEER ELECTRONICS ASIACENTRE PTE. LTD.

253 Alexandra Road, #04-01, Singapore 159936
TEL: 65-6472-7555

PIONEER ELECTRONICS AUSTRALIA PTY. LTD.

178-184 Boundary Road, Braeside, Victoria 3195, Australia
TEL: (03) 9586-6300

PIONEER ELECTRONICS OF CANADA, INC.

300 Allstate Parkway, Markham, Ontario L3R OP2, Canada
TEL: 1-877-283-5901

PIONEER ELECTRONICS DE MEXICO, S.A. de C.V.

Bldv.Manuel Avila Camacho 138 10 piso
Col.Lomas de Chapultepec, Mexico, D.F. 11000
TEL: 55-9178-4270

先鋒股份有限公司

總公司：台北市中山北路二段44號13樓
電話：(02) 2521-3588

先鋒電子（香港）有限公司

香港九龍尖沙咀海港城世界商業中心
9樓901-6室
電話：(0852) 2848-6488

Published by Pioneer Corporation.
Copyright © 2007 by Pioneer Corporation.
All rights reserved.

Printed in Thailand

<CRB2366-A/N> RC, RD, RI

<KMMZX> <07B00000>